

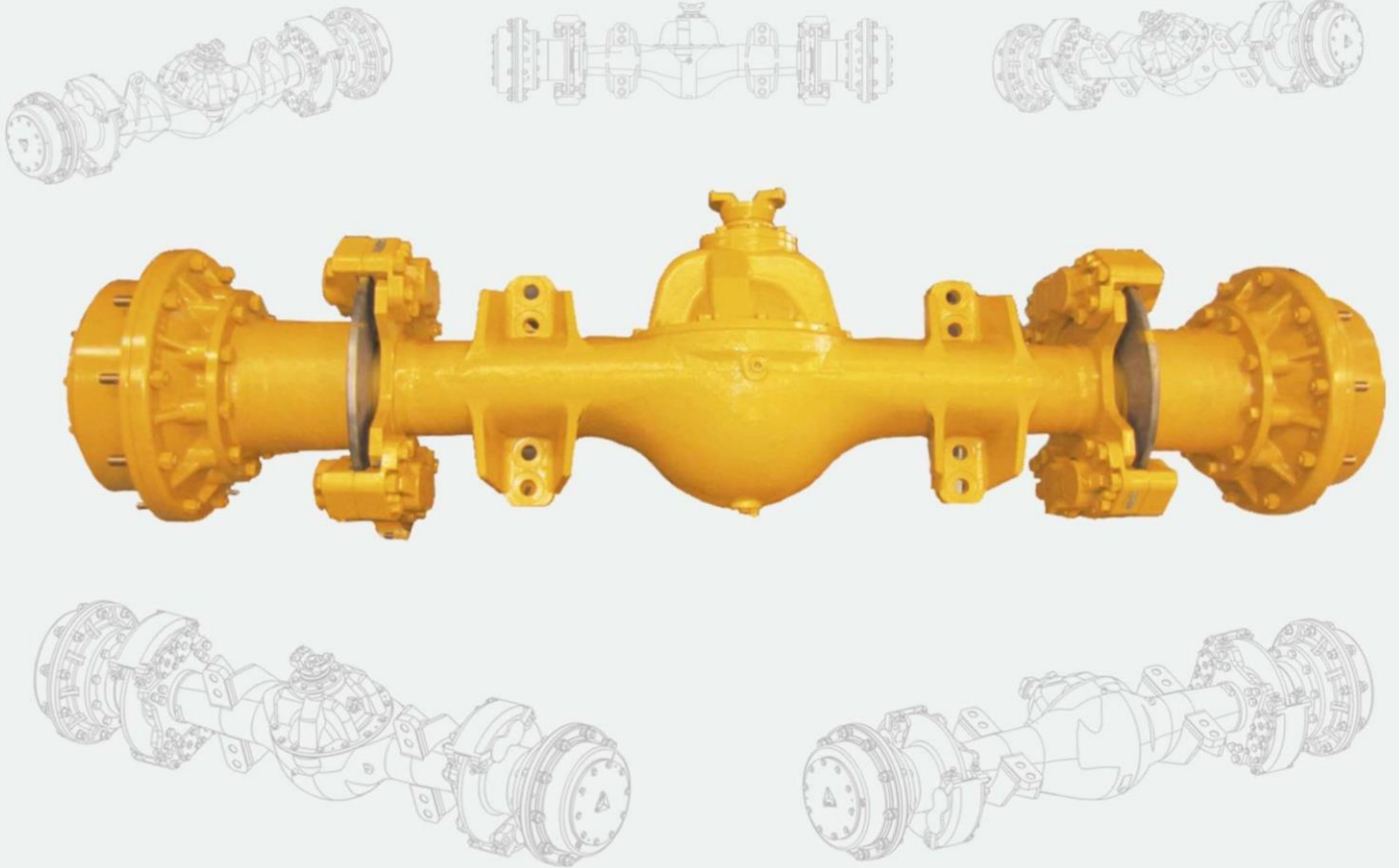

SERVICE MANUAL

LG Axle



Publ.NO.2938002051



LG Axle Service Manual

880×1230 mm 16# 18pieces

1st Edition in 2018. 10 1st Print

SHANDONG LINGONG CONSTRUCTION MACHINERY CO., LTD

Address: Linyi Economic Development Zone

Tel: 86-0539-8785688

Fax: 86-0539-8785698

Postal code: 276023

Website: www.sdlg.cn

Services Tel: 8008607999 4006587999 0539-8785800

Services Fax: 86-0539-8785671



Foreword

This service manual describes the structure and principles of the drive axle, and provides service technologies which can facilitate the maintenance personnel to understand the disassembling and assembling methods of drive axle, and lays a solid technical basis for the maintenance personnel to properly determine the fault and perform repair. Please read through this manual carefully to make it fully helpful.

The service manual includes the following parts:

- Introduction

This chapter mainly introduces the precautions for the repair of drive axle, marking and hoisting instructions and general thread tightening torque values.

- Structure and working principle of drive axle

This chapter describes the structure and working principles of various parts, which lays the foundation for the assembling and disassembling and also serves as reference data for troubleshooting.

- Disassembling of drive axle

This chapter describes the steps on how to properly disassemble various parts, and the relevant matters which shall be noted in the process of disassembling.

- Assembling of drive axle

This chapter describes the steps on how to correctly assemble various parts, and the relevant matters which shall be noted in the process of assembling.

- Criteria for the repair and replacement of drive axle parts

This chapter provides identification methods and the criteria for wear-out of common wearing parts.

- Diagnosis and Elimination of Common Fault

This chapter describes the diagnosis and troubleshooting of common faults as well as maintenance of drive axle.



Special Instruction

The service manual takes A512 drive axle as an example, and drive axles of other models manufactured by LG are similar with this model with respect to principle and main structure, with differences only in connection type, local structure, parts specifications and fuel charge, thus this service manual shall apply to the other models and no further description will be made otherwise.

Notice

Specifications of relevant parts referred to in this service manual are subject to change due to product improvement without prior notice. Please consult or ask Shandong Lingong Construction Machinery Co., Ltd. for the latest information.



Contents

1 Introduction	1
1.1 Safety Precautions	1
1.2 Marking Instructions	3
1.3 Hoisting Instructions.....	3
1.4 Table of General Bolt Tightening Torque	6
2 Structure and Working Principle of Drive Axle	7
2.1 External Structure of Drive Axle	7
2.1.1 Outside View of Drive Axle	7
2.1.2 Applicable Models and Main Parameters	8
2.2 Internal Structure of Drive Axle	10
2.3 Working Principles of Drive Axle	11
2.3.1 Differential Principle.....	11
2.3.2 Torque Distribution	13
2.3.3 Working Principle of Wheel Reducer	14
2.3.4 Transmission Principle of Drive Axle	15
3 Disassembling of Drive Axle	17
3.1 General Network Diagram of Disassembling	17
3.1.1 Instructions on Removed Parts.....	17
3.1.2 Tools and Equipment for Disassembling	18
3.2 Disassembling of Drive Axle	20
3.3 Disassembling of Assemblies	26
3.3.1 Disassembling of Planetary Carrier Assembly.....	26
3.3.2 Disassembling of Wheel Hub Assembly.....	28
3.3.3 Disassembling of Main Drive Assembly	30
3.3.4 Disassembling of Differential Assembly	35
3.3.5 Disassembling of Drive Spiral Bevel Gear Assembly	37
4 Assembling of Drive Axle.....	40



4.1 General Assembling Flow Chart	40
4.2 Coating Materials, Tools and Equipment for Assembling	41
4.3 Specifications and Precautions for Axle Assembling	43
4.3.1 Classification of and Tightening Methods for Threaded Fasteners of Axle	43
4.3.2 Precautions for Axle Assembling	44
4.4 Assembling of Drive Axle	46
4.5 Subassembling of Assemblies	56
4.5.1 Assembling of Wheel Hub Assembly	56
4.5.2 Assembling of Planetary Carrier Assembly	57
4.5.3 Assembling of Main Drive Assembly	58
5 Criterion for Repair and Replacement of Drive Axle Parts	76
6 Diagnosis and Elimination of Common Fault	78
6.1 Diagnosis and Elimination of Drive Axle Fault	78
6.1.1 Abnormal Noise of Drive Axle.....	78
6.1.2 Heating of Drive Axle	79
6.1.3 Oil Leak of Drive Axle.....	80
6.2 Drive Axle Maintenance	80
6.2.1 Oil Level Check.....	80
6.2.2 Maintenance	80
6.2.3 Other Inspections.....	81

1 Introduction

1.1 Safety Precautions

Key Points for Safety

Maintenance and repair are very important for safe operation of the vehicle. This manual mainly explains related techniques on how to properly disassemble and assemble the drive axle.

In order to prevent personnel injuries, in this manual  is used as a safety mark and any precaution with this mark means requiring being very careful when operating. In the case of potential risk, first consider your own safety and take necessary safety measures.

Safety Instructions

In the process of assembling and disassembling, improper operating methods can cause parts damage, reduced service life, performance deterioration and other unsafe factors. Therefore, for parts assembling and disassembling, please read the related information in this manual carefully.

1. Parameters, graphs and relevant content involved in this manual also apply to other products with standard configuration. For variant products, please consult our company or refer to the relevant documents.
2. In the repair shop there shall be a special area for parts assembling and disassembling and disassembled parts where relevant tools and parts shall be placed appropriately to ensure the tidiness of the work area without oil stain and contaminants. Smoke in the specified smoking area and never smoke in the working process. Besides, provide appropriate fire extinguishing apparatus in the workshop.
3. Welding operations, when necessary, must be undertaken by professionally trained and experienced personnel. During welding operations, the operator must wear welding gloves, baffle plate, goggles, safety helmet and other work clothes suitable for welding operations.
4. Before disassembling the drive axle assembly, remove the contaminants on the outer surface to avoid contamination of internal parts during disassembling.
5. During operation, wear safety boots and safety helmet. Wear work clothes complying with the







requirements with all the buttons buttoned. Wear goggles when knocking parts with a copper bar.

6. Use gasoline, kerosene and water-based oil cleaning agent to clean the removed parts.
7. When using a crane or other hoisting equipment, first check whether there is damage to the sling. Use hoisting equipment with sufficient hoisting capacity and, in the hoisting operation, utilize the designated hoisting position and slowly hoist to avoid collisions between parts. Never work under the hoisted parts.
8. If two or more operators are required to work simultaneously, the operating procedures must be agreed before the job, so as to avoid accidents caused by inconsistent action.
9. Keep all the tools properly and be familiar with their use.
10. When aligning two holes, do not insert your hand and fingers into the holes. For parts needing direct manual assembling, pay attention to whether the holding position will have risk of crush.
11. The disassembled parts must be detected, and those affecting the performance of the drive axle must be replaced with new ones. For specific criteria, see “5 Criteria for the Repair and Replacement of Drive Axle Parts”.
12. There shall be no interference between the assembled parts.
13. Take protection measures to oil seals and seal rings when passing through keyways, screw holes and steps during assembling to avoid damage to the oil seals and seal rings.
14. When assembling parts, the adopted tools must match the threaded fasteners to avoid damage to the latter.
15. When tightening the plug, do not use such tightening tools as pneumatic spanner, instead, screw the plug by hand to a certain extent, and then use the appropriate torque spanner to tighten to the required torque.
16. When draining the oil inside the drive axle, slowly unscrew the drain plug to prevent oil splashing, and hold the drained oil with a dedicated container to prevent environmental pollution.

1.2 Marking Instructions

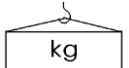
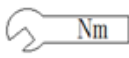
For the convenience of communication and memory, the following markings are used for important safety and quality requirements.

Table 1-1

Marking	Item	Remark
	Safety	Be careful in the process of operation.
		Be careful in the process of operation for there is internal pressure.
	Attention	Pay special attention to the technical requirements in the process of operation to ensure the quality requirements are met.
	Weight	Weight of parts or devices as well as assembling and disassembling methods. Pay attention to selecting the proper sling and the position adopted during hoisting.
	Tightening torque	Pay special attention to the tightening torque of the subassembly during assembling.
	Coating	Parts needing to be coated with adhesive and lubricating grease.
	Oil, water	Add certain quantity of oil, water or fuel.
	Drain	Place for oil or water discharge, and the discharge amount.

1.3 Hoisting Instructions

- If it is difficult to remove the components from the drive axle assembly, carry out the following checks:
 - Check whether all the fixing bolts at the component to be removed have been removed.
 - Check whether there is any other component at the component to be removed that interferes

with the removal operation.

2. Wire rope (or the hoisting rope with appropriate carrying capacity)
 - The wire rope must be hanged in the middle part of the hook. If it is at one end of the hook, then it may fall off from the hook in hoisting and cause serious accidents, and the middle part of the hook has the maximum strength.
 - Do not use only one wire rope but two or more instead and tie them around the load.

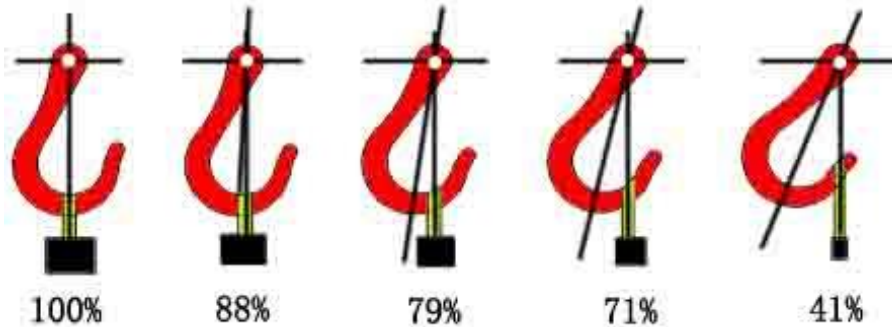

Fig. 1-1

⚠ Use of only one wire rope may cause spin of the hoisted parts, wire rope looseness or sliding of the hoisted parts from the original bundled position, resulting in accidents.

- When hoisting heavy load, the hoisting angle of the wire rope with respect to the hook shall not be too large.

When hoisting the load with two or more wire ropes, with the increased hoisting angle, the force borne by each wire rope also increases. Fig. 1-2 shows the variation of permissible load (kg) at various angles when hoisting the load with two wire ropes (maximum permissible vertical hoisting weight of 1000 kg for each one). When using two wire ropes for vertical hoisting, the total permissible hoisting weight can be 2000 kg. But at the hoisting angle of 120 °, the permissible hoisting weight can be only up to 1000 kg. On the other hand, at the hoisting angle of 150 °, the two wire ropes will bear a force of 4000 kg when the load is 2000 kg.

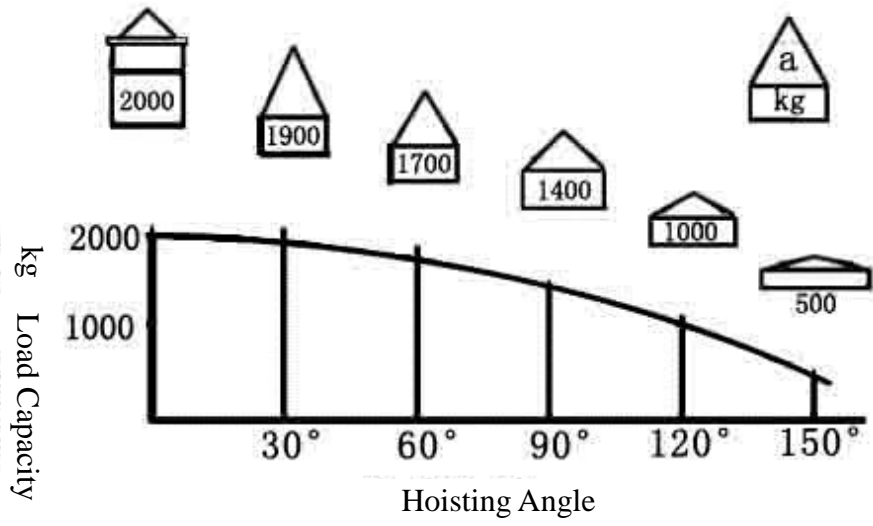

Fig. 1-2

1.4 Table of General Bolt Tightening Torque

Table 1-2

Bolt Strength Grade	Yield Strength N/mm ²	Nominal Diameter of Bolt: mm				
		6	8	10	12	14
		Tightening Torque N·m				
8.8	640	9~12	22~30	45~59	78~104	124~165
10.9	900	13~16	30~36	65~78	110~130	180~210
12.9	1080	16~21	38~51	75~100	131~175	209~278
Bolt Strength Grade	Yield Strength N/mm ²	Nominal Diameter of Bolt: mm				
		16	18	20	22	24
		Tightening Torque N·m				
8.8	640	193~257	264~354	376~502	521~683	651~868
10.9	900	280~330	380~450	540~650	740~880	940~1120
12.9	1080	326~434	448~597	635~847	864~1152	1098~1464
Bolt Strength Grade	Yield Strength N/mm ²	Nominal Diameter of Bolt: mm				
		27	30	33	36	39
		Tightening Torque N·m				
8.8	640	952~1269	1293~1723	1759~2345	2259~3012	2923~3898
10.9	900	1400~1650	1700~2000	2473~3298	2800~3350	4111~5481
12.9	1080	1606~2142	2181~2908	2968~3958	3812~5082	4933~6577

Notice:

During assembling the tightening torque of connecting bolt may be applied in accordance with the above table. In the case that the given tightening torque in the assembling of drive axle is different with that specified in this table, the tightening torque given in the assembling shall apply.

2 Structure and Working Principle of Drive Axle

2.1 External Structure of Drive Axle

2.1.1 Outside View of Drive Axle

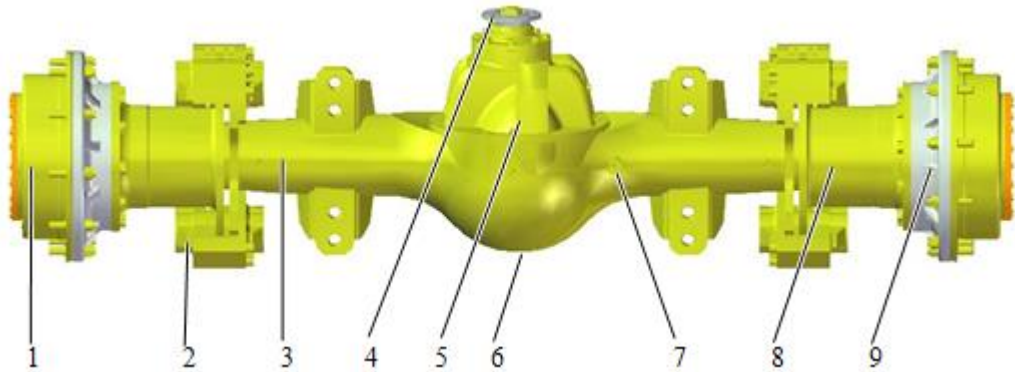

Fig. 2-1

1 Wheel reducer assembly 2 Brake caliper assembly 3 Axle housing 4 Input flange 5 Main drive 6 Oil filling plug 7 Vent hole 8 Brake disc 9 Wheel hub assembly 10 End cover 11 Drain plug

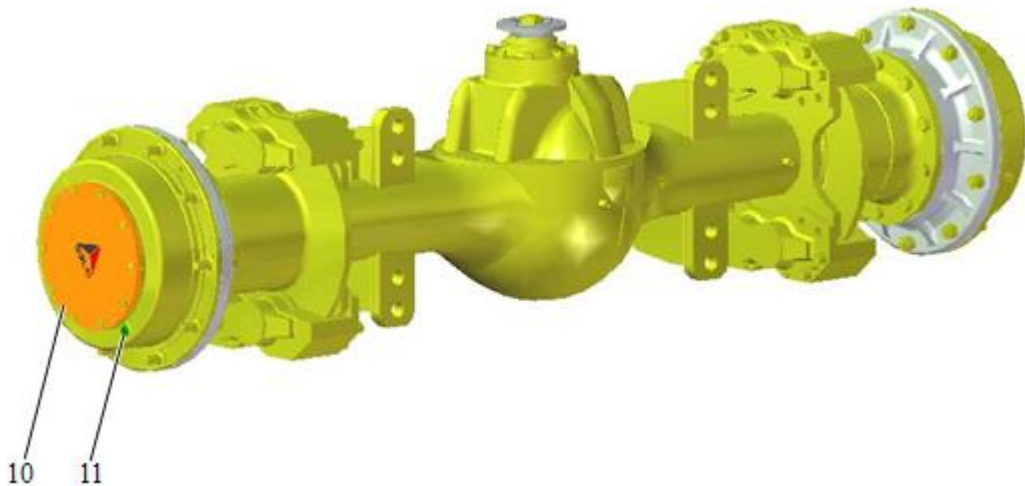

Fig. 2-2

2.1.2 Applicable Models and Main Parameters

Table 2-1

Axle Model	Reduction Ratio		Applicable Vehicle Model	Oil for Axle Gear Oil for Heavy-Duty Vehicle GL-5 85W-90 (GB13895-1992)	
	Main Drive	Wheel Reducer			
A503 Rear axle	3.7	5.6	L978F/LG978	37 L (22 L for axle body and 7.5 L for each wheel)	
A503 Front axle				44 L (28 L for axle body and 8 L for each wheel)	
A508B Rear axle			5.6	LG968/LG968V	34 L in total
A508B Front axle					
A508 Rear axle				LG968V	
A508 Front axle					
A508A Rear axle	4.11	LG956L/LG968N/LFT20/LFT30/LG970			
A508A Front axle		LG968/LG968N/LG956L/LFT20			
A503A Front axle	4.11	LG970/LFT30	44 L (28 L for axle body and 8 L for each wheel)		
A510 Rear axle		LG956、LG956L、LG956V	26 L (16 L for axle body and 5 L for each wheel)		
A506A Rear axle	4.625	4.875	LG918	9.6 L (6 L for axle body and 1.8 L for each wheel)	
A506A Front axle			LGB680 Loader-digger		
A511 Rear axle			L918/L920/LG916 /LG918/LG920	10 L (5 L for axle body and 2.5 L for each wheel)	
A511 Front axle					
A513 Rear axle		4.85		L920/LG926/LG918/LG920	9.6 L (6 L for axle body and 1.8 L for each wheel)
A513 Front axle					
A510A Rear axle		4.94	LG958/LG958L/LG968	32 L (20 L for axle body and 6 L for each wheel)	
A510A Front axle				33 L (25 L for axle body and 4 L for each wheel)	



LG Axle Service Manual

A510B Rear axle			LG956N	26 L (16 L for axle body and 5 L for each wheel)
A510 Front axle			LG956L/LG956V	33 L (25 L for axle body and 4 L for each wheel)
A512A Front axle			LG955N	26 L (16 L for axle body and 5 L for each wheel)
A512 Rear axle			L952(D)/LG952N/LG953(N)/LG955N	
A512 Front axle			L953(F)/L955F/LG953/LG952N/LG953N	
A515A Rear axle			LG958L	30 L (20 L for axle body and 5 L for each wheel)
A515A Front axle				
A515 Rear axle			LG956N/LG958N	
A515 Front axle				
A501A Front axle			LG956/LG958L	33 L (25 L for axle body and 4 L for each wheel)
A502B Front axle			LG953/LG953N/LG953L	26 L (16 L for axle body and 5 L for each wheel)
A502 Rear axle			LG952	27 L (17 L for axle body and 5 L for each wheel)
A502 Front axle			LG952/LG952H/LG952L/LG953/LG953L	26 L (16 L for axle body and 5 L for each wheel)
A504A Rear axle	5.286	4.4	LG948L	
A504A Front axle				
A504B Rear axle			LG946L	27 L (17 L for axle body and 5 L for each wheel)
A504B Front axle				
A504 Rear axle			L946/LG946L/ZL40F	26 L (16 L for axle body and 5 L for each wheel)
A504 Front axle				
A505E Rear axle			LG953/LG953N/LG953L	
A505 Rear axle			LG952H/LG952L/LG953/LG953L	
A507A Rear axle			LG938L	13 L (10 L for axle body and 1.5 L for each wheel)
A507A Front axle				
A507B Rear axl	6.17	3.12	LG933L	18 L (13 L for axle body and 2.5 L for each wheel)
A507B Front axle				
A507 Rear axle			L936/LG936L/LG938L/LG944MSK	
A507 Front axle				



Axle Model	Reduction Ratio		Applicable Vehicle Model	Oil for Axle Gear Oil for Heavy-Duty Vehicle GL-5 85W-90 (GB13895-1992)	
	Main Drive	Wheel Reducer			
A20-2 Front axle	3.9	4.94	L933/RS8140	18L (13L for axle body and 2.5L for each wheel)	
A20-2 Rear axle	5.28		RS8140		
AR28A-1 Rear axle			RS8260	26L (16L for axle body and 5L for each wheel)	
A16-2 Rear axle	3.9		L933		16L (12L for axle body and 2L for each wheel)
AL16A-3 Rear axle			LG933L/L933		
AK16A-1 Rear axle			LG936L		
A16-1 Rear axle			L936		
AL16A-2 Rear axle			L936/L938/LG936L/LG938L	18L (13L for axle body and 2.5L for each wheel)	
AL16H-1 Rear axle			L938F/LG938L		
AL20A-3 Front axle			LG933L		
AL20A-4 Front axle			L933		
A20-1 Front axle	L936		L936/L938/LG936L/LG938L		
AL20A-2 Front axle	L938F/LG938L				
AK45A-1 Front axle	5.28		5.6	LFT16/LFT18/LFT22	33L (23L for axle body and 5L for each wheel)
AK45A-1 Rear axle				LFT26	
AK45A Front axle	4.62	LFT30		39L (23L for axle body and 8L for each wheel)	
A503B Front axle		LFT26/LFT30			
AK45A Rear axle		L948/L948F		44L (28L for axle body and 8L for each wheel)	
A504C Front axle	5.28	4.4		L948/L948F	40L (24L for axle body and 8L for each wheel)
A504C Rear axle					
A515E Front axle	4.62	4.94		L953/L955F/L955FC/L956F	26L (16L for axle body and 5L for each wheel)
A515C Front axle				L956F/L956FH/L958F	
A515C Rear axle				L958F/LG958L	
A515G Front axle					
A515G Rear axle					
AL42A Front axle	4.11	5.6		L968F	35L (23L for axle body and 6L for each wheel)
AL36A Rear axle					36L (24L for axle body and 6L for each wheel)
AL42A-1 Front axle	3.7				35L (23L for axle body and 6L for each wheel)
AL36A-1 Rear axle			36L (24L for axle body and 6L for each wheel)		

2.2 Internal Structure of Drive Axle

- The drive axle assembly is one of the most important parts of the drive system. Its main functions are to decrease the speed, increase the transmission output torque, cause speed difference of the wheels at both sides, bear the load, and transmit the power.
- The loader drive axle assembly mainly consists of axle housing, main drive (including differential), half axle, wheel reducer, brake caliper assembly and other parts. Among them, the main driver and the wheel reducer are the parts with the function of reduction and differential: the former is mainly composed of the input flange, oil seal cover, bearing sleeve, drive spiral bevel gear, driven spiral bevel gear, bracket, differential (planetary gear, cross shaft, face gear, left differential housing, right differential housing and gasket) bearing, adjusting gasket, thrust bolt and framework oil seal; and the latter is mainly made up of inner ring gear, planetary carrier, planetary gear, sun gear and gasket. The main internal structure is as shown below.
- The power between the main drive and the wheel reducer is transmitted through the half axle by meshing the splines at both sides of the half axle with the face gear in the differential and the sun gear in the wheel reducer.

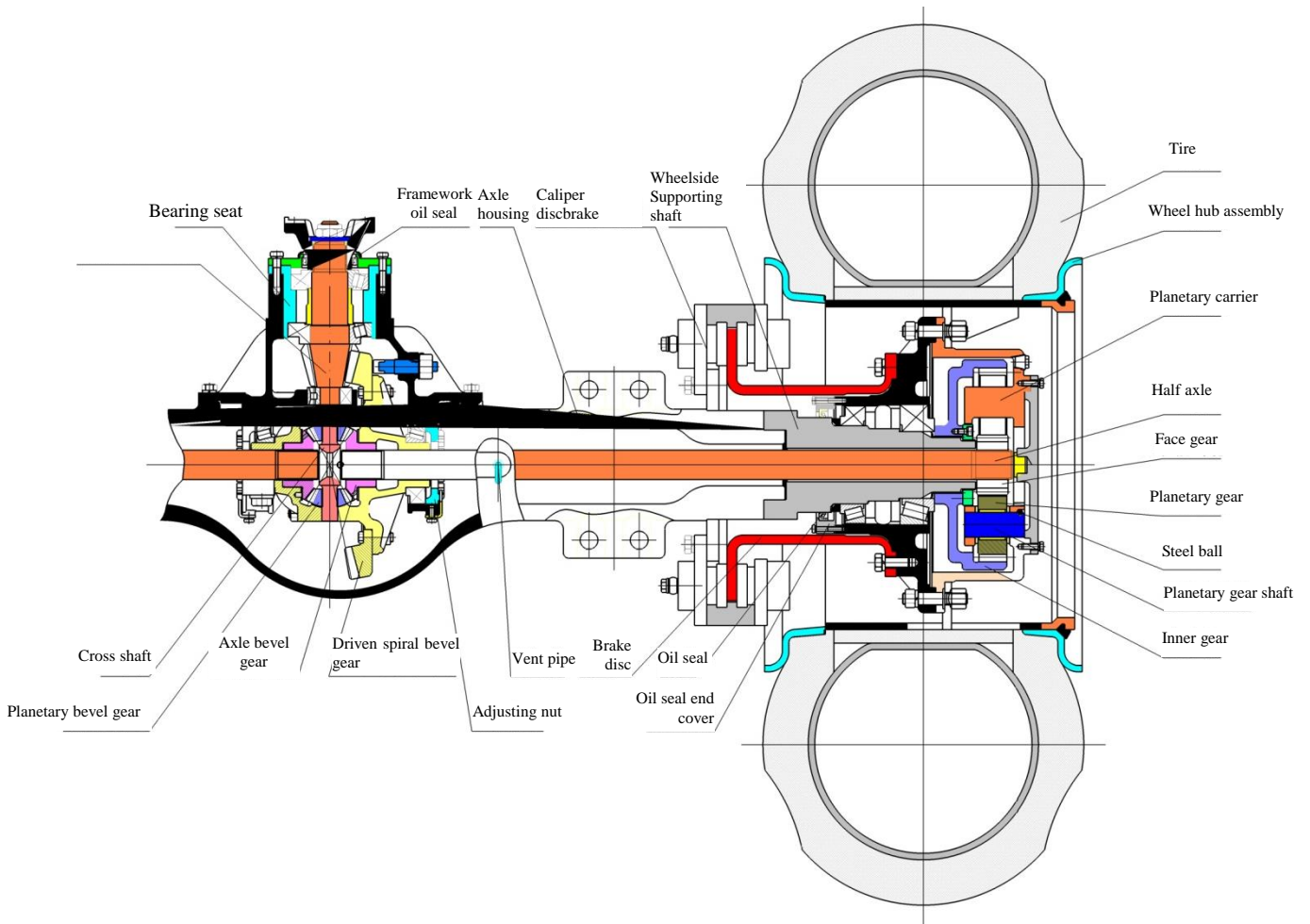

Fig. 2-3

2.3 Working Principles of Drive Axle

The functions of torque increase, speed decrease and differential are realized mainly with the differential and the wheel reducer. The working principles are as follows:

2.3.1 Differential Principle

The moving relationship between the elements in common symmetrical bevel gear differential—differential principle can be illustrated with the following diagram. Symmetrical bevel gear differential is a kind of planetary gear structure. The differential housing 3 integrates with the cross shaft 5 to form the planetary carrier. As it is also connected with the driven spiral bevel gear 6, the differential housing, cross shaft and driven spiral bevel gear share the same speed. Let their angular speed be ω_0 . To the differential, they are drive elements; the face gears 1 and 2 are driven elements and their angular speeds are respectively ω_1 and ω_2 . A and B are the meshing points of the

planetary gear 4 with the face gears 1 and 2. C is the center of the face gear, and the distances between A, B, C and the rotating axle of the differential are all r.

If the planetary gear just revolves along with the planetary carrier around the rotating axle of the differential, obviously, the circumferential speed of A, B and C with the same radius (r) will be the same: $\omega_0 r$. In this way, $\omega_0 = \omega_1 = \omega_2$, i.e. the differential does not work, and the angular speed of the half axle equals to that of the differential housing 3.

If the planetary gear 4 rotates around its axis 5 at the angular speed of ω_4 besides revolution, the circumferential speed at the meshing point A will be $\omega_1 r = \omega_0 r + \omega_4 r_4$ (given the planetary gear radius is r_4) and the circumferential speed at the meshing point B will be $\omega_2 r = \omega_0 r - \omega_4 r_4$. Then:

$$\omega_1 r + \omega_2 r = (\omega_0 r + \omega_4 r_4) + (\omega_0 r - \omega_4 r_4)$$

Namely

$$\omega_1 + \omega_2 = 2\omega_0$$

This is the kinetic characteristic equation of symmetrical bevel gear differential. As is shown, the speed sum of the left and the right face gears equals to two times of the differential housing speed at all times and has nothing to do with the planetary gear speed. Therefore, if the loader steers or works under other conditions, the planetary gear may rotate at corresponding speed to enable the drive wheels at both sides to roll on the ground with different speeds without slipping. It also shows that:

- (1) If the speed of the face gear at one side is zero, the speed of the face gear at the other side will be two times of that of the differential housing;
- (2) If the speed of the differential housing is zero and the face gear at one side rotates due to other external torques, the face gear at the other side will rotate in reverse direction at the same speed.

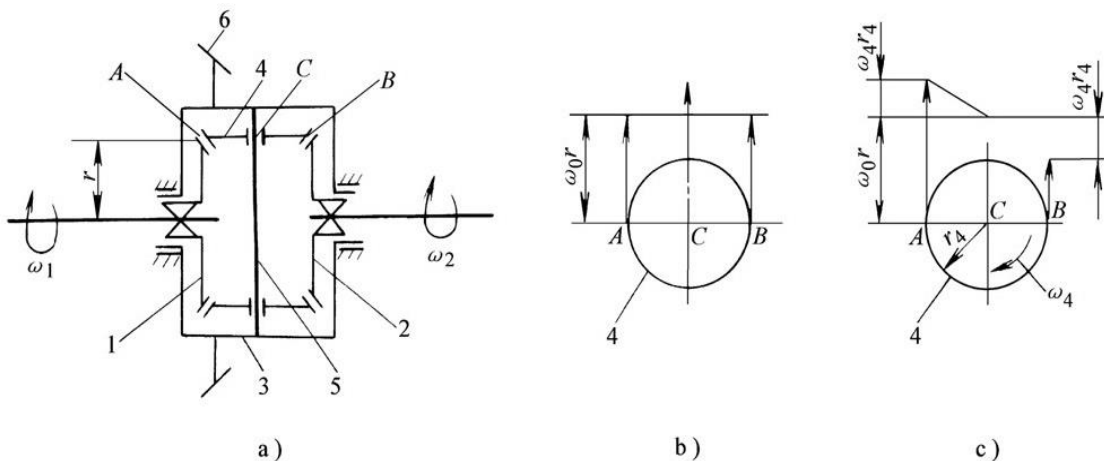

Fig. 2-4 Differential Principle

1&2 Face gear 3 Differential housing 4 Planetary gear 5 Cross shaft 6 Driven spiral bevel gear

2.3.2 Torque Distribution

The torque of the common symmetrical bevel gear differential is distributed as this: when the planetary gear do not rotate, the torque M_0 transmitted from the final reducer is always equally distributed to the left and the right face gears, i.e. $M_1 = M_2 = M_0/2$.

If the two face gears rotates in the same direction at different speeds, namely in case of speed difference, given the left face gear speed n_1 is greater than the right one n_2 , then the planetary gear will rotate around the cross shaft in the direction of the arrow n_4 as shown in Fig. 2-4. At this time, friction occurs between the planetary gear hole and the cross shaft journal and between the gear back and the differential housing. The direction of the friction torque M_r which the planetary gear is subject to is opposite to the direction of its rotation, n_4 . On the other hand, this friction torque makes the planetary gear additionally exert two circumferential forces F_1 and F_2 of the same magnitude yet in opposite direction on the left and the right face gears. F_1 decreases the torque M_1 transmitted to the faster left face gear while F_2 increases the torque M_2 transmitted to the slower right face gear.

Hence, in case of speed difference between the left and the right drive wheels, the torque difference between the left and the right wheels equals to the internal friction torque M_r of the differential. Namely: $M_1 = (M_0 - M_r) / 2$, $M_2 = (M_0 + M_r) / 2$.

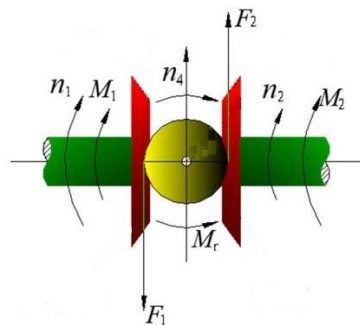

Fig. 2-5 Differential Torque Distribution

- The widely used symmetrical bevel gear differential shows small internal friction torque. It can be deemed to some extent that no matter the left and the right drive wheels share the same speed or not, the torque is basically equally distributed at all times, and this is the power transmission characteristics of common differential that “different speed but the same torque”. Such a distribution proportion is reasonable for driving in straight line under good road

condition. However, it affects trafficability badly when a vehicle travels under extremely tough road condition. An example is that when the drive wheel at one side touches the muddy or icy or snowy road, the wheels on muddy road slip while the wheels on good road stay put. This is because the adhesion between the wheels on muddy road and the road is so small that the road only exerts little reaction torque on the half axle; though the adhesion between the wheels on the other side on the good road and the road is larger, due to the characteristic of equal torque distribution of the symmetrical bevel gear differential, the torque distributed to the wheels on this side has to be the same as the small torque transmitted to the slipping drive wheels, which results in total driving force not enough to overcome the driving resistance and makes it impossible to go ahead.

2.3.3 Working Principle of Wheel Reducer

- Wheel reducer is the last torque increasing and speed decreasing mechanism in the drive system. It is of planetary drive type, comprised of drive sun gear, fixed ring gear, driven planetary carrier, planetary gear, etc., and its working principle is as shown below. (This is a schematic diagram only for introduction of working principle)

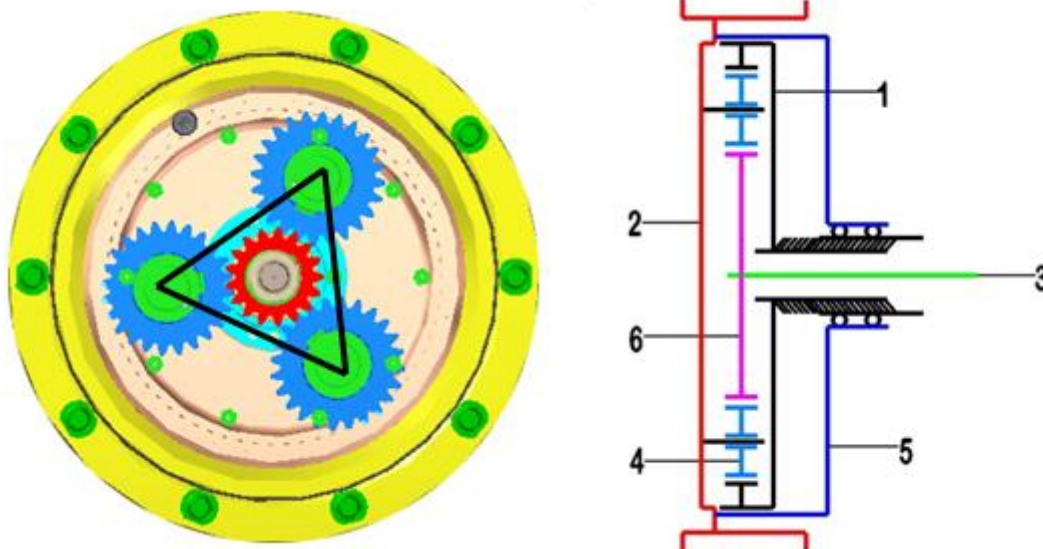

Fig. 2-6 Working Principle of Wheel Reducer

1 Inner ring gear 2 Planetary carrier 3 Half axle 4 Planetary gear 5 Wheel hub 6 Sun gear

- The sun gear and the half axle are combined through the spline, and the unmovable inner ring

gear is fixed onto the wheelside supporting shafts on the two ends of the drive axle housing. The planetary gear that meshes with the sun gear and the inner ring gear is mounted onto the planetary carrier through the steel ball and the planetary gear shaft. The planetary carrier and the wheel rim are fixed together through the rim bolt. Therefore, the rim and the planetary carrier rotate together.

- In order to improve the meshing conditions of the sun gear and the planetary gear and distribute the mashing load equally, the half axle is made loose without fixed support.

2.3.4 Transmission Principle of Drive Axle

As can be known from Fig. 2-4 which shows the main internal structure of drive axle, the left and the right housings of the differential are combined through bolts.

- The driven spiral bevel gear of the main drive is fixed onto the flange of the right differential housing with bolts. The journal of the cross shaft is embedded in the hole formed by the corresponding groove of the interface between the left and the right housings. A planetary gear is loosely slipped in each journal and meshes with the two straight bevel face gears. And the journals of the two face gears are supported in the corresponding left and right seat holes of the differential housings and connected with the half axle with the internal spline.
- Half axle refers to the solid axle that transmits power between the differential and the wheel reducer. Its inner end is connected with the face gear of the differential through the spline while its outer end connected with the sun gear of the wheel reducer through the spline and the retainer ring. The left and right half axles of the loader drive axle are of full floating type, which enables the two ends of the half axles to bear the torque. To prevent the half axle from axial play under the action of lateral force, a steel ball is located at the joining position with the wheel reducer end cover to limit its position. The torque and the motion transmitted from the main drive are transferred to the half axle through the differential and then to the wheel reducer through the half axle.
- The sun gear and the half axle are combined through the spline, and the unmovable inner ring gear is fixed onto the wheelside supporting shafts on the two ends of the drive axle housing. The planetary gear that meshes with the sun gear and the inner ring gear is mounted onto the

planetary carrier through the steel ball and the planetary gear shaft. The planetary carrier and the wheel rim are connected through the rim bolt. Therefore, the rim and the planetary carrier rotate together.

- The transmission route can be known based on this structure:

Transmission (power) \implies Drive shaft \implies Input flange \implies Drive spiral bevel gear \implies
Driven spiral bevel gear \implies Left & right differential housings \implies Cross shaft \implies Planetary
bevel gear \implies Face gear \implies Half axle \implies Sun gear \implies Planetary gear \implies Planetary
carrier \implies Rim assembly \implies Drive wheel.

3 Disassembling of Drive Axle

3.1 General Network Diagram of Disassembling

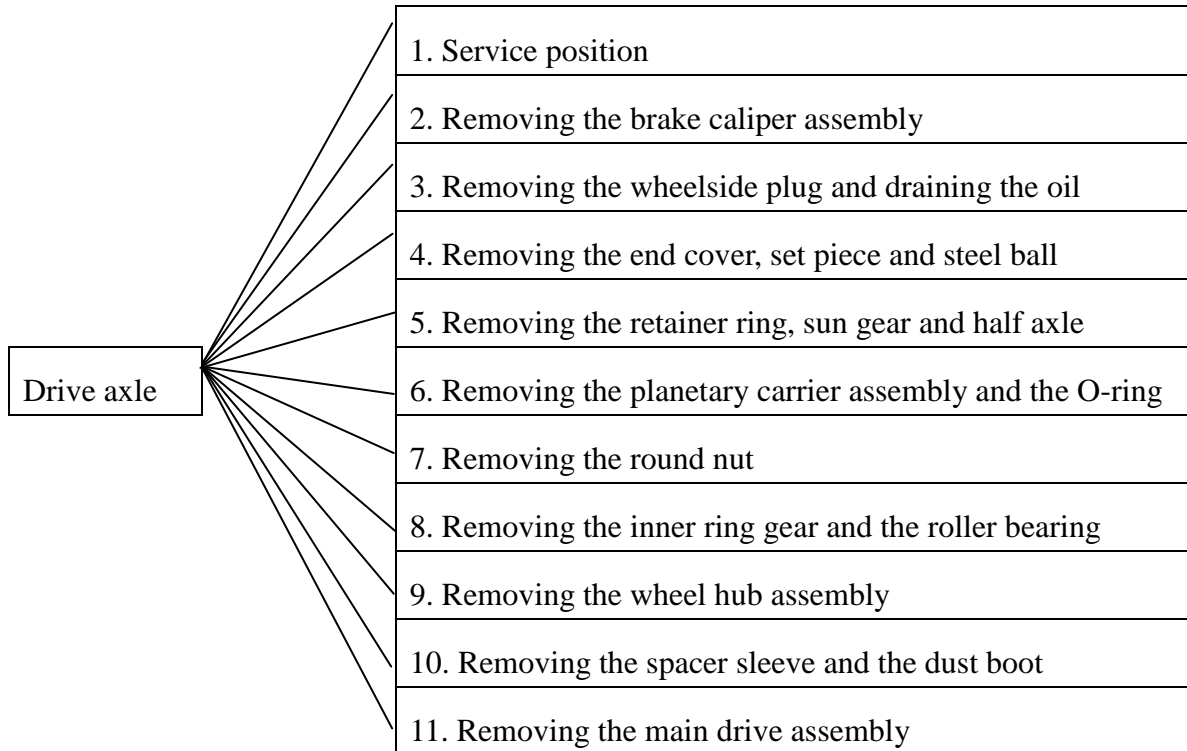

Fig. 3-1

3.1.1 Instructions on Removed Parts

- Never reuse any removed seal but replace with a new one instead;
- Some bearings in-plant installed by the method of shrinkage fitting-up or press fitting-up show large interference. Therefore, the removed ones may be damaged. In case that damage to the bearing surface is caused during operation, it shall be repaired to meet the service requirements before use, or else, it shall be scrapped.
- Knock slightly with the copper bar and prevent any debris from splashing into the assembled part cavity, or use the rubber hammer, plastic hammer or other press fitting methods.

3.1.2 Tools and Equipment for Disassembling

Table 3-1











General Tool						
Tool Name	Open-end spanner	Hexagon socket spanner	Retainer pliers	Dead-blow hammer	Copper bar	Right-angled screwdriver
Part Used	Select the corresponding specifications based on the bolt size	Fix screws and plugs with round nuts	Sun gear and main drive bearing	Spacer sleeve and dust boot	Slightly knock on the tight parts	Thrust bolt locking plate, etc.

Table 3-2

Special Tool	Tool Name	Part Used	Remark
	Drive axle jig	Supporting the drive axle	If unavailable, equip the disassembling bench
	Round nut spanner	Round nut at the wheelside inner ring gear	
	Bearing extractor	Wheel hub bearing	
	Bearing puller	Drive and driven spiral bevel gear bearings	

	<p>Pressing sleeve</p>	<p>Framework oil seal end cover</p>	<p>Composed by positioning sleeve and movable pressing sleeve</p>
	<p>Main drive bracket</p>	<p>Supporting the main drive</p>	<p>If unavailable, equip the disassembling bench</p>



Fig. 3-2

1 Bracket

2 Drive axle

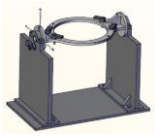
3.2 Disassembling of Drive Axle

- 1 Clean away the mud and stain on the drive axle assembly.
- 2 Prepare a stable drive axle mounting bracket.
- 3 Put the drive axle assembly on the bracket such that the main drive assembly faces upward.



Fig. 3-3

1 Brake caliper

- 4 Removing the brake caliper assembly
Unscrew the bolt connecting the brake caliper assembly with the brake caliper bracket and remove the brake caliper assembly.

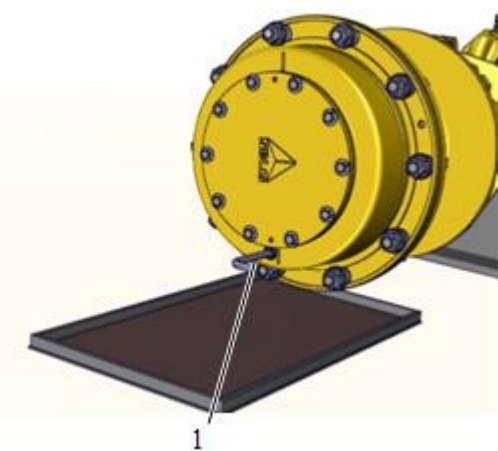

Fig. 3-4

1 Plug

- 5 Removing the plug
Loosen the plug with an appropriate tool and unscrew it by hand.
Put a clean container under it and prepare to hold the oil.

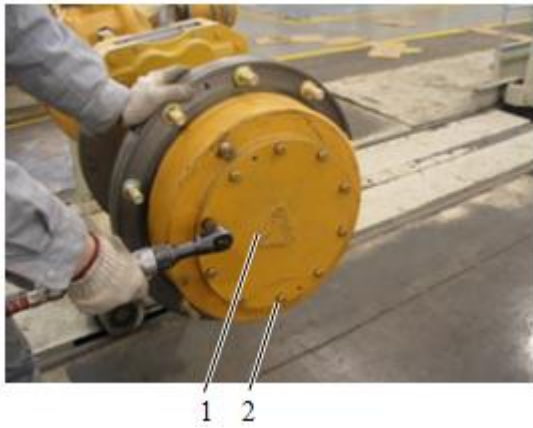

Fig. 3-5

1 End cover

2 Bolt and washer

6 Removing the end cover

Loosen the bolt connecting the planetary carrier with the end cover.

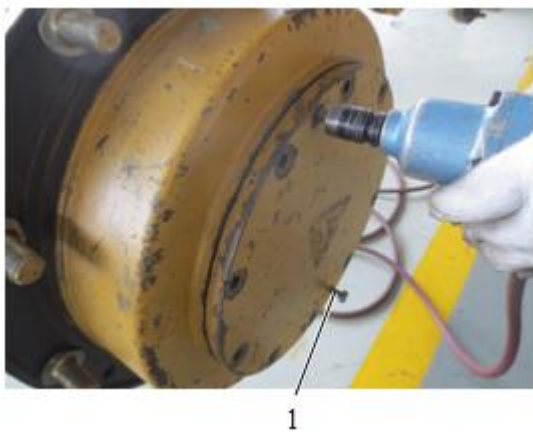

Fig. 3-6

1 Jackscrew

7 Use M10 jackscrew to push the end cover away from the planetary carrier and remove the end cover.



Fig. 3-7

1 Set piece

2 Steel ball

8 Removing the set piece

Remove the set piece and the steel ball by hand.

If they are too tight, appropriate tools may be used to pry them out.



Fig. 3-8

1 Steel ball



Fig.3-9

1 Retainer ring

2 Retainer pliers

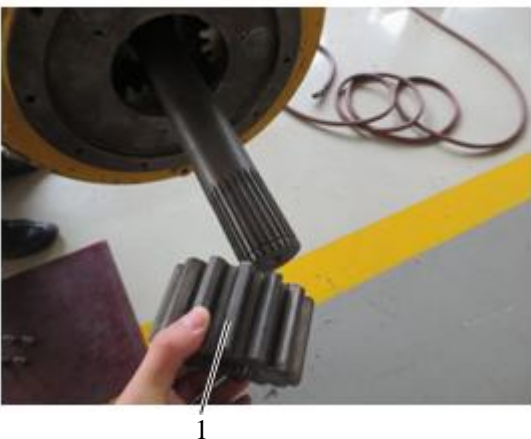

Fig. 3-10

1 Sun gear

9 Removing the steel ball

Remove the locating point of the steel ball with appropriate tools and knock the steel ball out.

10 Removing the retainer ring

Remove the retainer ring from the retainer ring groove of the half axle with the shaft retainer pliers.

Before removing the retainer ring, take part of the half axle and the parts on it out of the axle housing.

⚠ Notice:

Clamp the retainer pliers firmly so as to prevent the retainer ring from popping out and causing potential safety hazard.

11 Removing the sun gear

Remove the sun gear from the half axle by hand gently.



Fig. 3-11

1 Half axle

12 Removing the half axle

Remove the half axle from the axle housing by hand gently.

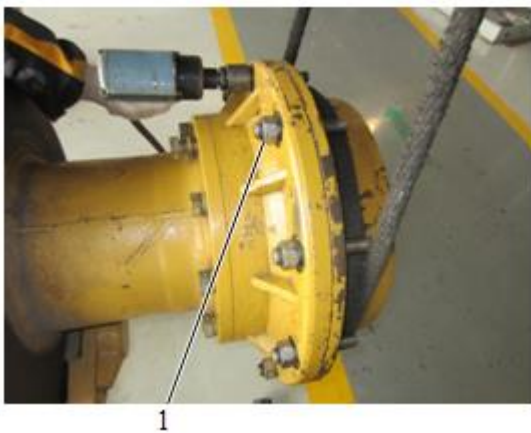

Fig. 3-12

1 Rim bolt

13 Removing the planetary carrier

Loosen the rim bolt M20 with the appropriate tools, prop loose the planetary carrier from the wheel hub with jackscrew M16, and remove the planetary carrier assembly.

⚠ Notice:

When propping loose the planetary carrier with the jackscrew, the staff member shall work in the safe area, and the operation shall be slow in case that the planetary carrier assembly drops and causes danger.

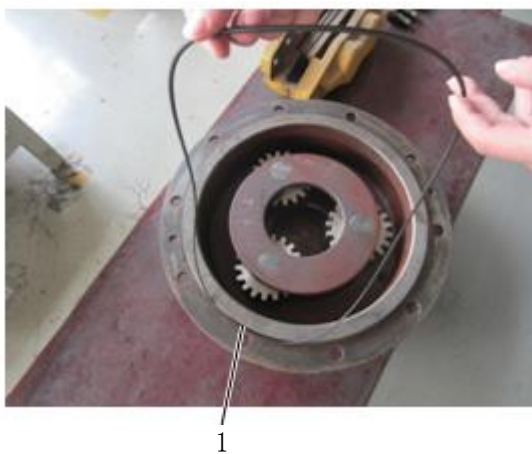

Fig. 3-13

1 O-ring

14 Removing the O-ring.

Remove the O-ring from the planetary carrier.



15 Removing the round nut

Loosen the screw M10 and then remove the round nut with appropriate tools.

Fig. 3-14

1 Round nut



16 Removing the inner ring gear

Remove the inner ring gear by hand.

Fig. 3-15

1 Inner ring gear



17 Removing the roller bearing

Remove the bearing cone by hand.

Fig. 3-16

1 Bearing cone

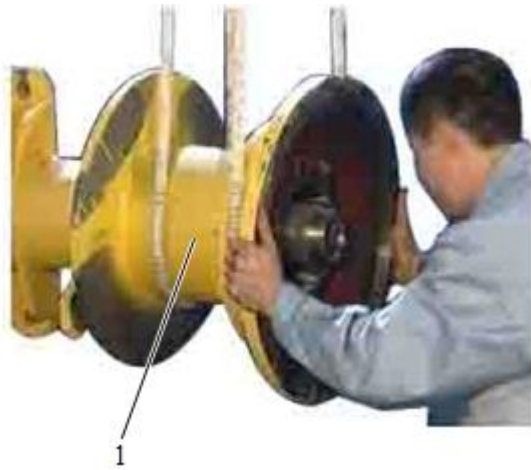

Fig. 3-17

1 Wheel hub assembly

18 Removing the wheel hub assembly

Remove the wheel hub assembly from the wheelside supporting shaft.

★Notice:

During hoisting, make the axis of the wheel hub assembly and the axis of the wheel reducer supporting shaft overlap as far as possible in case that the oil seal surface and the parts in it may be damaged during disassembling.

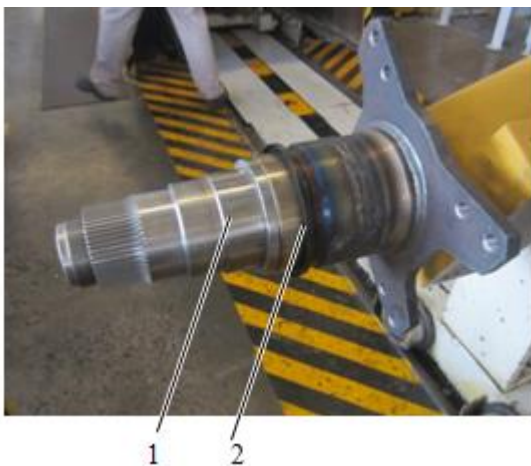

Fig. 3-18

1 Spacer sleeve 2 Dust boot

19 Removing the spacer sleeve and the dust boot

Remove the spacer sleeve and the dust boot, and remove all the parts at the other end of the drive axle in the same way.

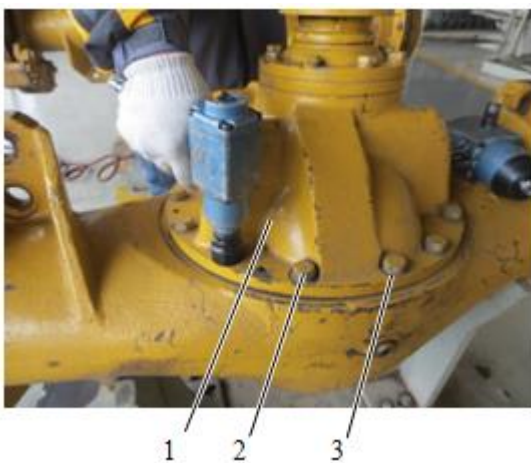

Fig. 3-19

1 Main drive 2 Bolt 3 Washer

20 Removing the main drive assembly

Remove the bolt connecting the main drive with the axle housing assembly with appropriate tools, and hoist it down to proper position.

★Notice:

When hoisting the main drive assembly, make sure the sling is right over the main drive assembly in order not to bump against the parts in it.

3.3 Disassembling of Assemblies

3.3.1 Disassembling of Planetary Carrier Assembly

- 1 Put the planetary carrier assembly horizontally on the disassembling bench.

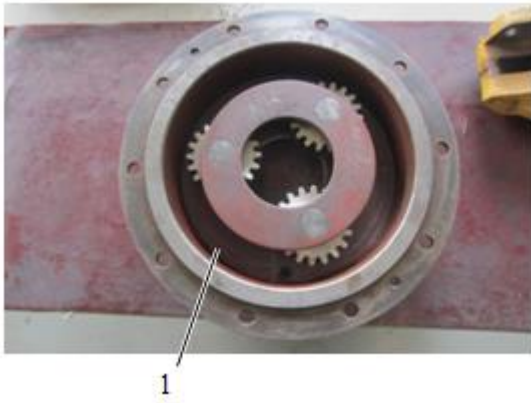

Fig. 3-20

1 Planetary carrier

- 2 Knock out the planetary gear shaft with the copper bar gently.



Fig. 3-21

1 Planetary gear shaft

- 3 Remove the steel ball.



Fig. 3-22

1 Steel ball



4 Remove the planetary gear and the gasket.

★ Notice:

Before removing the planetary gear, knock out all three planetary gear shafts.

Fig. 3-23

1 Planetary gear

2 Gasket

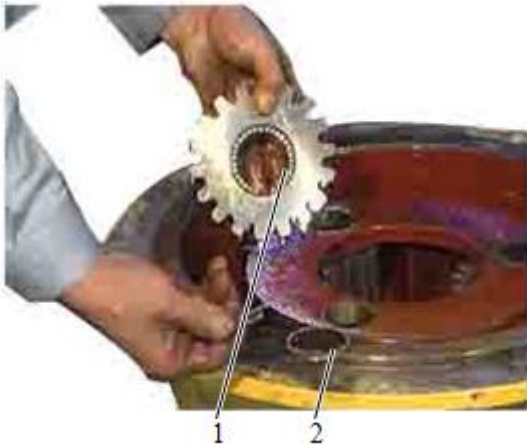

5 Remove the retainer ring and then the needle on the inside wall of the planetary gear.

Fig. 3-24

1 Needle

2 Retainer ring

3.3.2 Disassembling of Wheel Hub Assembly

- 1 Put the wheel hub assembly horizontally on the disassembling bench.



Fig. 3-25

1 Wheel hub assembly



- 2 Loosen the bolt connecting the brake disc and the wheel hub with appropriate tools.

Fig. 3-26

1 Gasket

2 Bolt



- 3 Remove the brake disc.

Fig. 3-27

1 Brake disc



- 4 Remove the bolt connecting the oil seal end cover with the wheel hub with appropriate tools, and remove the oil seal end cover.

Fig. 3-28

- 1 Oil seal end cover
- 2 Bolt and gasket



- 5 Remove the gasket.

Fig. 3-29

- 1 Gasket



- 6 Remove the framework oil seal.

Fig. 3-30

- 1 Framework oil seal



- 7 Remove the bearing.

Fig. 3-31

1 Bearing

3.3.3 Disassembling of Main Drive Assembly



- 1 Put and fix the main drive on the jig horizontally (with the input flange upward).

Fig. 3-32

1 Main drive

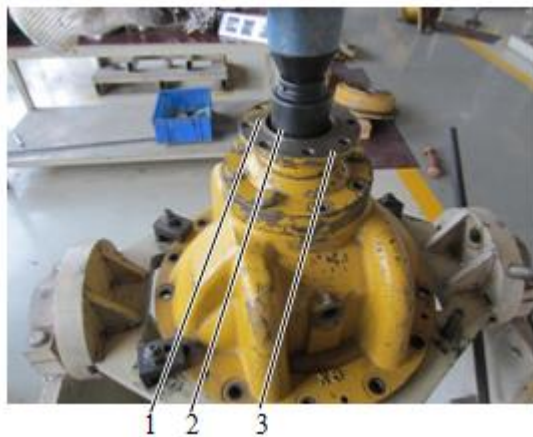

- 2 Remove the locking nut with appropriate tools, and remove the input flange and the gasket.

★Notice:

Make a mark before removing for the purpose of assembling.

Fig. 3-33

1 Locking nut 2 Washer 3 Input flange



Fig. 3-34

1 Bolt and gasket

2 Sealing cover

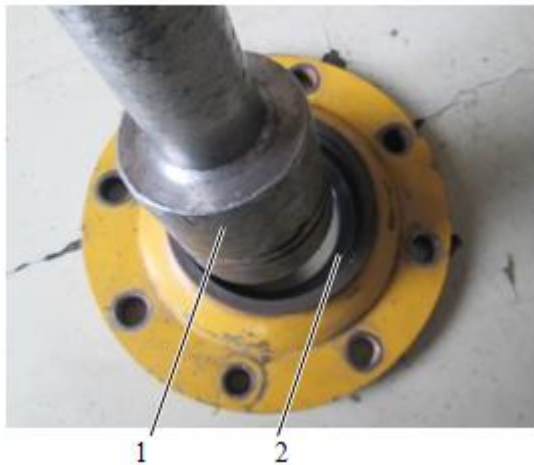

Fig. 3-35

1 Pressing sleeve

2 Framework oil seal



3 Remove the bolt connecting the sealing cover with the bearing sleeve with appropriate tools, and remove the sealing cover.

4 Remove the framework oil seal from the sealing cover with the pressing sleeve.

5 Remove the sealing gasket.

Fig. 3-36

1 Sealing gasket

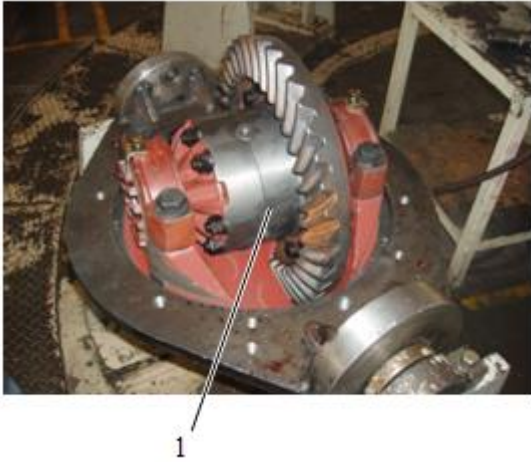

6 Turn the main drive over by 180 °.

Fig. 3-37

1 Main drive



7 Make a mark in order to fit it into the original position when reassembling.

Fig. 3-38



8 Remove the bolt and the washer fixing the locking plate, and remove the locking plate.

Fig. 3-39

1 Bolt and washer

2 Locking plate



Fig. 3-40

1 Bolt and washer

2 Bearing seat



Fig. 3-41

1 Adjusting nut



Fig. 3-42

1 Thrust bolt

2 Locking plate

9 Remove the bearing seat connecting bolt with appropriate tools, and remove the bearing seat.

10 Remove the adjusting nut by hand.

11 Knock flat the locking plate locking the thrust bolt, and remove the nut, the locking plate and then the thrust bolt.



Fig. 3-43

1 Differential

12 Hoist out the differential assembly and put it at a proper place.

★**Notice:**

Hoist in a balanced way to avoid safety risks.



Fig. 3-44

1 Drive spiral bevel gear assembly

2 Bracket

13 Separate the drive spiral bevel gear assembly from the bracket with the copper bar.

⚠**Notice:**

Do not knock the drive spiral bevel gear assembly too hard in case it suddenly drops to cause part damage and safety risks.

3.3.4 Disassembling of Differential Assembly

- 1 Put the differential assembly on the disassembling bench and ensure its stability.



Fig. 3-45

1 Differential

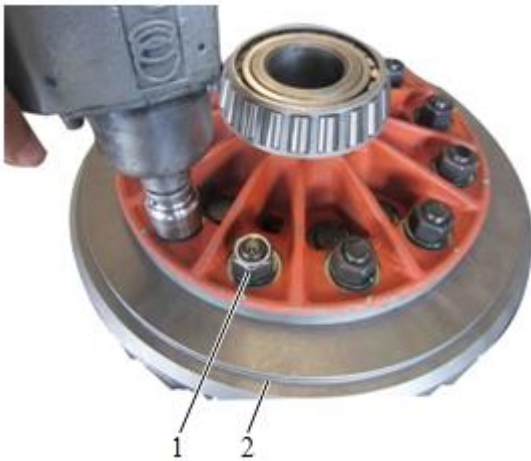

- 2 Loosen the nut connecting the driven spiral bevel gear and the right differential housing, and remove the driven spiral bevel gear.

★ **Notice:**

Before removing the driven spiral bevel gear, check or make an assembling mark in order to fit into the original position when reassembling.

Fig. 3-46

1 Nut 2 Driven spiral bevel gear



- 3 Remove the bearings on the left and the right differential housings.

Fig. 3-47

1 Bearing



- 4 Loosen the nut connecting the left and the right differential housings to separate them.

★ Notice:

Before separating the left and the right differential housings, check or mark an assembling marking in order to fit into the original position when reassembling.

Fig. 3-48

1 Bolt 2 Differential housing



- 5 Remove the face gear gasket and the face gear.

Fig. 3-49

1 Face gear 2 Gasket



- 6 Remove the cross shaft and the differential gear together. Remove the differential gear gasket and the differential gear from the cross shaft.

Fig. 3-50

1 Cross shaft

2 Differential gear

3 Differential gear gasket



7 Remove the face gear gasket and the face gear.

Fig. 3-51

1 Face gear

2 Face gear gasket

3.3.5 Disassembling of Drive Spiral Bevel Gear Assembly

1 Put the drive spiral bevel gear assembly on corresponding disassembling bench, set the bearing sleeve flange up, and exert pressure on the thread end of the drive spiral bevel gear with a holddown.

★ Notice:

Do not exert pressure too hard in case that the flange may be damaged. Push the bearing sleeve away from the drive spiral bevel gear.



Fig. 3-52

1 Drive spiral bevel gear assembly



Fig. 3-53

1 Bearing

- 2 Remove the bearing.



Fig. 3-54

1 Bearing sleeve

- 3 Remove the bearing sleeve.



Fig. 3-55

1 Bearing cup

- 4 Remove the bearing outer ring.

- 5 Remove the adjusting gasket.



Fig. 3-56

1 Adjusting gasket

- 6 Remove the spacer sleeve.



Fig. 3-57

1 Spacer sleeve

4 Assembling of Drive Axle

4.1 General Assembling Flow Chart

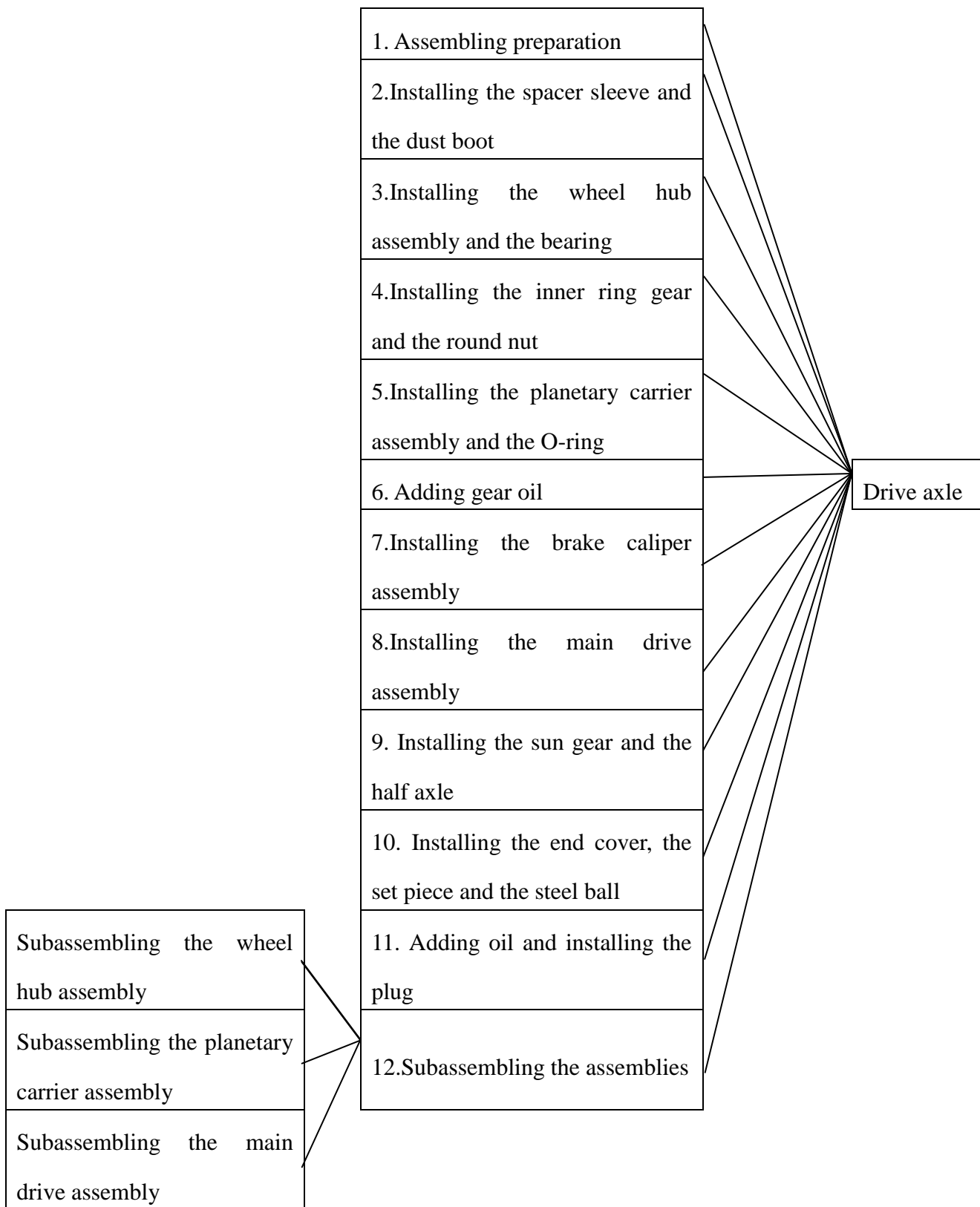







Fig. 4-1







4.2 Coating Materials, Tools and Equipment for Assembling

Table 4-1

Name	Code	Scope of Application and Function
Sealant	1545 anaerobic pipe thread sealant	Applicable to the sealing of hydraulic system, pneumatic system and cooling equipment pipe threads and the surface with slight oil stain.
	1262 thread locking sealant	Applicable to the locking and sealing of M10 ~ M20 threaded fasteners or threaded parts bearing strong vibration and impact.
	1596 silicone rubber plane sealant	Applicable to the sealing of junction surfaces of reducer, pump, valve, internal-combustion engine, etc.
Lubricating grease	No. 2 or No. 3 lithium base lubricating grease GB 7324-1994	Applicable to the lubrication of roller bearings, sliding bearings and friction parts of various construction equipment used within the temperature of -20 ~ 120°C.
Cleaning agent	1755 Cleaning agent	Applicable to the cleaning of metal surfaces for effectively eliminating surface oil stain and increasing the bonding strength between the sealant, thread locking agent and the matrix.

Table 4-2

General Tool						
Tool Name	Open-end spanner	Hexagon socket spanner	Retainer pliers	Dead-blow hammer	Copper bar	Right-angle screwdriver
Part Used	Select the corresponding specifications based on the bolt size	Fix screws and nuts with round plugs	Sun gear and main drive bearing	Spacer sleeve and dust boot	Slightly knock on the tight parts	Thrust bolt locking plate, etc.

General Tool						
Name	Dial indicator	Magnetometer stand	Socket	Tensiometer	Vernier caliper	Torque spanner
Part Used	Backlash of spiral bevel gear	Used with the dial indicator	Select the specification based on the actual situation	Flange rotating torque	Axle gear gasket pin	Apply the torque based on the actual situation
Special Tool	Tool Name	Part Used			Remark	
	Drive axle jig	Supporting the drive axle			If unavailable, equip the disassembling bench	
	Round nut spanner	Round nut at the wheelside inner ring gear				
	Bearing pressing sleeve	Wheel hub bearing and main drive bearing				
	Pressing sleeve	Framework oil seal end cover			Composed by positioning sleeve and movable pressing sleeve	
	Main drive bracket	Supporting the main drive			If unavailable, equip the disassembling bench	

4.3 Specifications and Precautions for Axle Assembling

4.3.1 Classification of and Tightening Methods for Threaded Fasteners of Axle

Though the analysis of assembling performance, process, operation and quality requirements for axle series products and in combination with oil penetration and leakage prevention, the threaded fasteners of axle are classified into A, B and C levels as per the importance.

Table 4-3

	No.	Assembling Part	Assembling Method
Level A threaded fasteners	1	Wheelside end cover bolt	<ul style="list-style-type: none"> Firstly, screw in the fastener for more than 2 ~ 3 pitches by hand, and then use a pneumatic spanner to pretighten the fastener at low speed and small torque on the principle of symmetrical crossing. Finally, turn at least 30° with a torque spanner of the corresponding specification to achieve the specified (median) torque. The intelligent tightening machine may also be used in case that its accuracy is guaranteed and the specified (median) torque must be achieved.
	2	Bolt and nut connecting the left and right housings of differential	
	3	Driven spiral bevel gear bolt and nut	
	4	Main drive sealing cover bolt	
	5	Bolt connecting the bracket and the axle case	
	6	Bolt connecting the wheelside oil seal end cover	
Level B threaded fasteners	1	Bolt connecting the wheel hub and the brake disc	<ul style="list-style-type: none"> Firstly, screw in the fastener for more than 2 ~ 3 pitches by hand, and then use a pneumatic
	2	Brake caliper bolt	

	3	Bolt and nut connecting the planetary carrier and the wheel hub	spanner of the same specification or lower specification to pretighten the fastener on the principle of symmetrical crossing. • Finally, tighten the fastener with a torque spanner of the corresponding specification to achieve the specified (median) torque.
	4	Nut fastening the flange	
	5	Bolt connecting the bracket and the bearing seat	
Level threaded fasteners	1	Bracket locking plate bolt	
	2	Axle body plug	
	3	Wheelside plug	

4.3.2 Precautions for Axle Assembling

1. Prior to the assembling, eliminate any scrap iron, burr, oil stain, silt and other impurities. Make sure no corrosion, scratch or bruise is allowed on fitting surfaces and friction surfaces. Keep the oil port and groove clean and smooth.
2. During the assembling, never bruise the bolt thread.
3. Make sure the bolt head and the nut end face evenly contact with the tightened part plane without any inclination. Never use a hammer to knock on the two planes for contact, and make sure the threaded rod has no bending or deformation.
4. Make sure the connected parts are evenly stressed, closely contacted and firmly connected.
5. Never use improper spanners or sockets to tighten bolts and nuts.
6. Assemble the axle in strict accordance with the above specified fastener levels. In principle, it is not allowed to replace the high-performance fastener with a low-performance fastener or vice versa.
7. Coat the external threads of threaded fastener with appropriate thread locking sealant along the circumference but neglecting the first two threads, with a coating width of 3 ~ 5 threads, and then screw in the internal threads to the specified torque. In case that the internal hole is a blind one, coat the blind hole bottom with appropriate sealant and then perform the tightening action.
8. Screw in bolts and screws for more than 2 ~ 3 pitches by hand during their assembling; and then pretighten them with tools; finally, tighten them with the torque spanner of the corresponding

specification to achieve the specified torque.

9. Protect the paint film and clad layer of connected parts during the assembling of bolts, screws and nuts; and also protect the bolt and nut heads and screw slots against damage.

10. Use a suitable thread tapper if the thread hole is required to be repaired and make sure the axis of thread hole is perpendicular to the surface of connected part.

11. Make sure 2 ~ 3 pitches of bolt and screw heads are exposed out of the nut end face after tightening the nut.

12. Pretighten the packaged bolts and nuts in certain sequence according to the shape of connected part and the distribution of bolts.

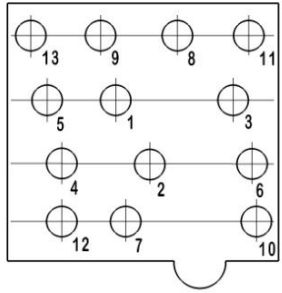
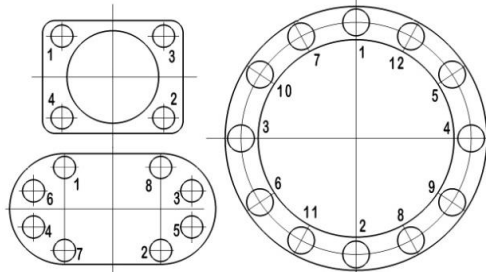
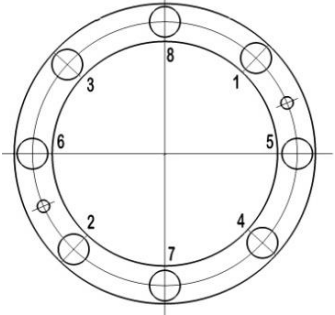
		
<ul style="list-style-type: none"> ● For the oblongly-arranged packaged bolts or nuts, tighten the central ones firstly, and then gradually extend to the both sides symmetrically. 	<ul style="list-style-type: none"> ● For the circularly-arranged or squarely-arranged packaged bolts or nuts, tighten them symmetrically. 	<ul style="list-style-type: none"> ● If any dowel pin, begin with the bolts near the dowel pin.

13. Be sure to wear heat-insulating gloves when installing heated bearings to prevent from being scalded.

14. Knock slightly with the copper bar and prevent any debris from splashing into the assembled part cavity, or use the rubber hammer, plastic hammer or other press fitting methods.

4.4 Assembling of Drive Axle

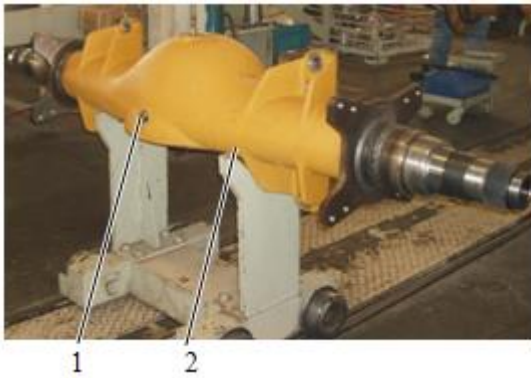

Fig. 4-2

- 1 Plug
- 2 Axle housing

1 Installing the drive axle housing

Hang the clean axle housing assembly on the special jig. Screw glued plugs into the oil drain port and the oil filling port in the axle body.

Nm Plug: 85±15 Nm

Tonnage (T)	Axle Model	Torque
1	A513/A506	85±15 Nm
3	A507	
4	A504	
5	A512	
6	A508	
7	A503	260±20 Nm



Fig. 4-3

- 1 Spacer sleeve
- 2 Dust boot

2 Installing the spacer sleeve and the dust boot

Install the bearing spacer sleeve and dust boot onto the wheelside supporting shaft of axle housing assembly.

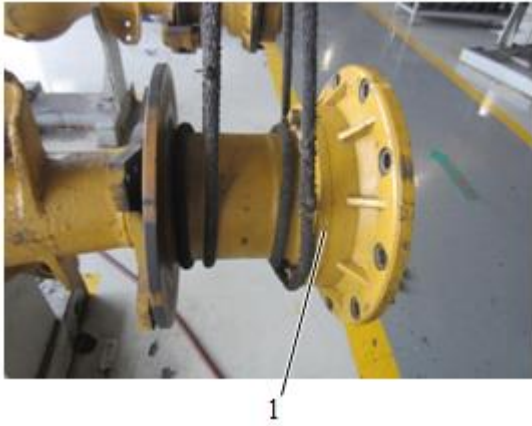

Fig. 4-4

1 Wheel hub assembly

3 Installing the wheel hub assembly

Apply lubricating oil to the wheelside supporting shaft of axle housing assembly, and then install the wheel hub assembly onto the supporting shafts at both ends of axle housing assembly.

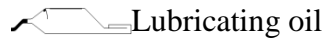

Fig. 4-5

1 Bearing

4 Installing the bearing

Heat the inner ring of roller bearing to 50°C ~ 100°C, and then install the roller bearing onto the wheelside supporting shafts.



Fig. 4-6

1 Inner ring gear

5 Installing the inner ring gear

Install the inner ring gear of drive axle at the spline of supporting shaft end, and then rotate the wheel hub by hand to make the bearings at both ends in place.



6 Installing the round nut

Install and tighten the round nut.

Fig. 4-7

1 Round nut



Fig 4-8

1 Tensiometer

- Hook the $\Phi 22.5$ hole in the wheel hub with a tensiometer and pull the tensiometer along the tangent line to see if its reading is within the range of 45 ~ 75 N. In case that the reading is out of the above range, adjust the tightness of the round nut as per the reading and repeat the above process until the reading of the tensiometer is within 45 ~ 75 N. Finally, coat 5 ~ 6 threads of the threaded hole in the internal gear used for mounting the screw with 1262 thread locking sealant from the second thread (form a liquid film on the 1/3 circle of the thread), and tighten the screw and fix the round nut.

- Prior to measuring the tension, rotate the wheel hub back and forth for at least 5 circles.

 1262 thread locking sealant

 Nm Screw: 45 ± 5 Nm

Tonnage (T)	Axle Model	Torque	
		Screw	Wheel Hub Pretightening Force
1	A513 A506	26±4 Nm	40 ~ 70 N
3	A507		24 ~ 56 N
4	A504	40~50 Nm	45 ~ 75 N
5	A512	45±5 Nm	
6	A508		
7	A503		

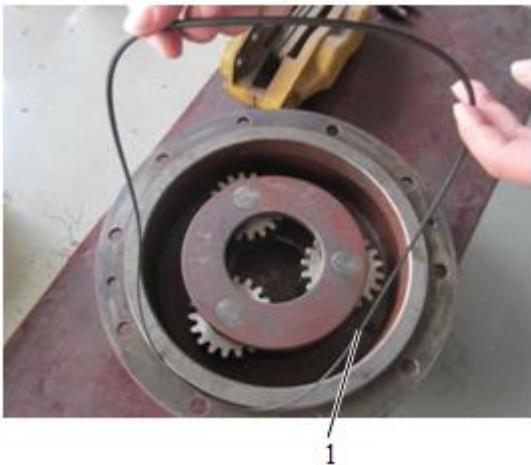

7 Installing the O-ring

Install the O-ring onto the planetary carrier assembly.

Fig. 4-9

1 O-ring



8 Installing the planetary carrier assembly

Install the planetary carrier assembly and the O-ring onto the wheel hub with rim bolts, washers and nuts.

Nm 510±30 Nm

Fig. 4-10

1 Planetary carrier

Tonnage (T)	Axle Model	Torque
1	A513/A506	310±40 Nm
3	A507	309±45 Nm
4	A504	510±30 Nm
5	A512	
6	A508	
7	A503	



9 Adding gear oil

Add 2-L GB13895-1992 SAE 85W-90 GL-5 gear oil into the two wheel reducers respectively.



SAE 85W/90 GL-5 gear oil

Fig. 4-11



10 Installing the brake caliper assembly

Make the end face of axle housing horizontally upward, install the disc brake caliper assembly at the other side of axle body onto the brake caliper bracket and fix it with bolts and washers.



Nm 430±50 Nm

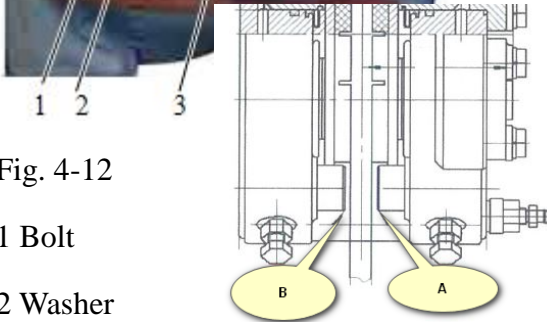

Fig. 4-12

1 Bolt

2 Washer

3 Brake caliper

Tonnage (T)	Axle Model	Torque	Clearance
1	A513/A506	225±32 Nm	A:37(-0.5,0) B:17(0,+0.5)
3	A507	420±50 Nm	
4	A504	376 ~ 502 Nm	
5	A512	430±50 Nm	
6	A508		
7	A503	500±40 Nm	



11 Adding gear oil

Add 16-L GB13895-1992 SAE 85W/90 GL-5 gear oil into the axle body.



SAE 85W/90 GL-5 gear oil

Fig. 4-13



1

Fig. 4-14

1 Sealant

12 Installing the main drive assembly

- Coat the junction surface between the axle housing and the bracket with 1598 silicone rubber plane sealant. For the large end face of axle housing, coat the inner side of threaded hole with a closed $\phi 3 \sim \phi 5$ circle of sealant and apply such sealant to the circumference of threaded hole at the two sides of R40 arc; apply appropriate 1262 thread locking sealant to the inner side of threaded hole in the axle body for installing the main drive assembly bolt.

- The sealant shall not be exposed to the air for more than 10 minutes.

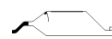
 1598 silicone rubber plane sealant

- Hoist the main drive assembly with a crane, locate the main drive in the main drive housing of axle and install the dowel pin.

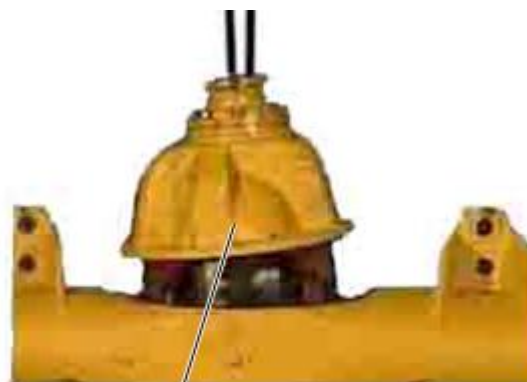

1

Fig. 4-15

1 Main drive



Fig. 4-16

1 Bolt and washer

- Apply appropriate 1262 thread locking sealant to the bolt, and then tighten the main drive assembly and the axle housing assembly with bolts and washers.

Nm 225 ±32 Nm

1262 thread locking sealant

★ **Notice:**

Tighten the bolts on the principle of symmetrical crossing.

Tonnage (T)	Axle Model	Torque
1	A513/A506	120 ±10 Nm
3	A507	120 ±10 Nm
4	A504	225 ±32 Nm
5	A512	
6	A508	182 ±16 Nm
7	A503	195 ±15 Nm

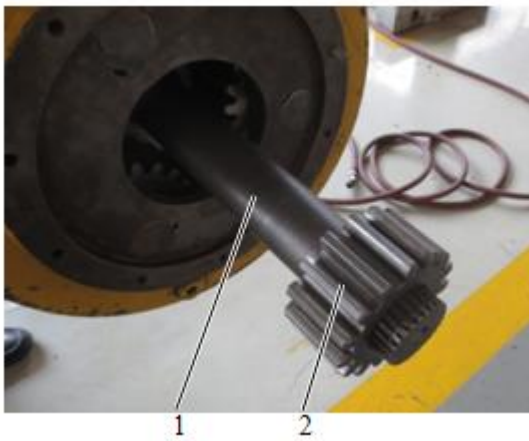

Fig. 4-17

1 Half axle

2 Sun gear

13 Installing the sun gear

Install the sun gear onto the end of half axle with the retainer ring groove.



14 Installing the retainer ring

Install the retainer ring with the shaft retainer pliers.

⚠ Notice:

Clamp the retainer pliers firmly so as to prevent the retainer ring from popping out during the installation and causing potential safety hazard.

Fig. 4-18

1 Retainer ring



15 Installing the half axle

Install the half axle connected with sun gear into the wheel hub (pay Notice to the match between the spline of half axle and the spline within the face gear).

Fig. 4-19

1 Half axle



16 Installing the steel ball

Rivet the steel ball onto the set piece while enabling the steel ball to rotate flexibly.

Fig. 4-20

1 Steel ball



17 Installing the set piece

Install the set piece riveting the steel ball onto the end cover.

★ Notice:

In case that the installation is not in place, use appropriate tools to slightly knock on the part while ensuring the steel ball can rotate flexibly.

Fig. 4-21

1 Set piece

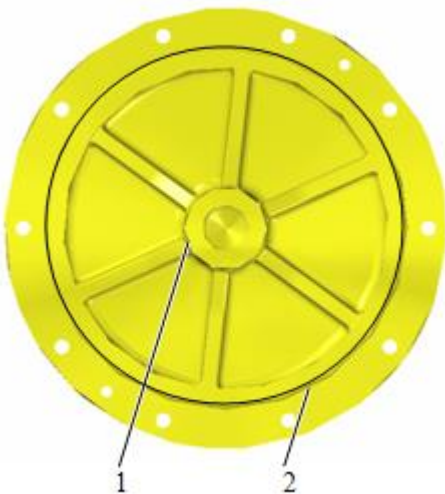

18 Installing the end cover

Apply a sealant line with a diameter of 4 mm on the cover as shown in the figure; coat the inner side of threaded hole with appropriate 1262 thread locking sealant.

 1262 thread locking sealant

Fig. 4-22

1 End cover

2 Sealant applying route on the cover



19 Tightening the end cover with bolts and washers

 Nm 45 ± 5 Nm

★ Notice:

Tighten the bolts on the principle of symmetrical crossing.

Fig. 4-23

1 Bolt and washer

2 End cover

Tonnage (T)	Axle Model	Torque

1	A513/A506	52 ± 7 Nm
3	A507	45 ± 5 Nm
4	A504	
5	A512	
6	A508	180 ~ 210
7	A503	195 ± 15 Nm



Fig. 4-24

20 Adding gear oil

Add 3-L GB13895-1992 SAE 85W-90 GL-5 gear oil into the two wheel reducers respectively

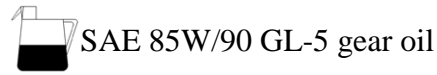

21 Installing the plug

Screw the plugs coated with sealant into the wheelside oil ports.

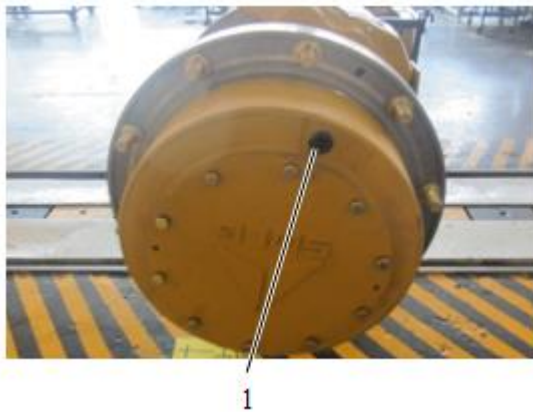
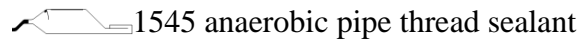

Fig. 4-25

1 Plug

Tonnage (T)	Axle Model	Torque
1	A513/A506	85 ± 15 Nm
3	A507	
4	A504	
5	A512	
6	A508	100 ± 10 Nm
7	A503	85 ± 15 Nm

4.5 Subassembling of Assemblies

4.5.1 Assembling of Wheel Hub Assembly



Fig. 4-26

1 Bearing inner ring



Fig.4-27

1 Framework oil seal



Fig. 4-28

1 Bolt and washer 2 End cover

- 1 Put the big end of the wheel hub upward to install the bearing outer ring. Then turn it over with the small end of the wheel hub up to install the bearing outer ring and inner ring.

- 2 Apply the lubricating oil in the end cover of the oil seal and check the soundness of the oil seal; evenly apply the lubricating oil in the groove of the framework oil seal and then install it in the end cover of the oil seal.

- 3 Install the gasket on the small end face of the wheel hub and then the oil seal end cover on the small end of the wheel hub and fasten it with bolts M8*45 and washers.

Nm : 26±4 Nm

- 4 Install the brake disc on the wheel hub and fasten it with bolts M20*1.5*50 and washers.

Nm : 330±50 Nm

★ Notice:

Fasten each bolt on the principle of symmetrical crossing.



Fig. 4-29

1 Bolt and washer

Tonnage (T)	Axle Model	Torque	
		Oil seal end cover	Brake disc
1	A513 A506		120±10 Nm
3	A507	26±4 Nm	225±25 Nm
4	A504		330±50 Nm
5	A512		
6	A508		226±31 Nm
7	A503		

4.5.2 Assembling of Planetary Carrier Assembly

1 Paste the needles on the inner bore wall of the planetary gear with lubricating grease, and install retainer rings on both ends of the needles; install the gaskets on both ends of the planetary gear hole and finally install them together into the planetary carrier seat hole.

★ Notice:

During assembling, the needles shall be selected such that the difference between the maximum diameter and minimum diameter of the needles in the same group shall be less than 0.005. The components purchased from SDLG can be assembled directly if they meet these requirements.

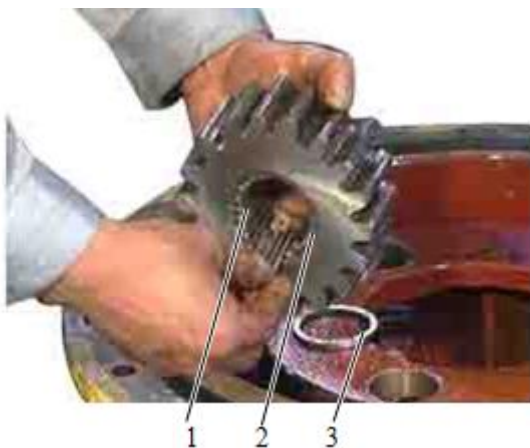

Fig. 4-30

1 Needle 2 Planetary gear

3 Retainer ring



Fig. 4-31

1 Planetary gear shaft

2 Steel ball

- 2 Install the steel ball inside the planetary gear shaft hole with the ball aligned with the semi-circular hole of the planetary carrier, and then install it and the planetary gear shaft on the planetary carrier by passing through the inner holes of the planetary gear and the gasket. After the assembling is completed, the planetary gear shall be rotated flexibly and without seizure.

4.5.3 Assembling of Main Drive Assembly

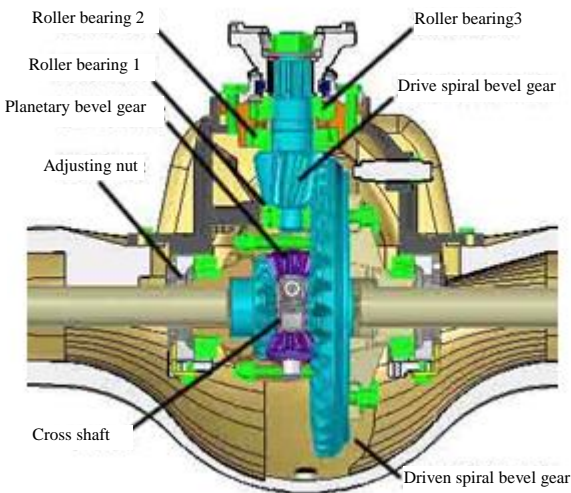

Fig. 4-32

- 1 Press the outer ring of roller bearing 3 into the bearing seat hole.
- 2 Install the roller bearing 1 on the end journal of the drive spiral bevel gear (including the left and right spirals, with the former used for the front axle and the latter used for the rear axle) with a press machine, and then install the retainer rings in order;
- 3 Turn it over and press the roller bearing 2 into the other end of the drive spiral bevel gear with a press machine.



- 4 Install shaft sleeves in order.

Fig. 4-33

1 Shaft Sleeve



- 5 Install the gasket.

Fig. 4-34

1 Gasket



- 6 Install the bearing sleeve (containing the bearing outer ring).

Fig. 4-35

1 Bearing outer ring

2 Bearing sleeve



Fig. 4-36

1 Roller bearing

2 Drive spiral bevel gear

7 In the end, press it into the inner ring of the roller bearing. See Fig. 4-36.

- When assembling the main reducer, the tapered roller bearing shall bear a certain assembly preload by applying a certain pre-tightening force based on eliminating the bearing clearance, aiming at reducing its axial displacement caused by the axial force generated during the transmission process, improving the axle support stiffness and ensuring the normal engagement of the bevel gear pair. However, excessive tightness will accelerate the wear of the tapered roller bearing.

- Standard requirement: The rotary resistance torque of the flange shall be 0.43-3.46 Nm, after the drive spiral bevel gear assembly is installed into the bracket shell and the flange is installed and fastened with big nuts (torque 360 ± 40 Nm).

- Assembling method: (take A512 as an example)

- a) After the pre-selected pre-tightening force gasket for the drive spiral bevel gear is installed, fasten the flange with big nuts (torque 360 ± 40 Nm) and put them on the special bracket; on the premise that the drive spiral bevel gear is fixed and cannot rotate, hook the $\Phi 14.5$ hole on the bearing sleeve with a push-pull dynamometer. The reading of the pull-push dynamometer shall be 5 ~ 35 N while the dynamometer is pulled in the tangential direction, or else the gasket thickness shall be increased or reduced.



Fig. 4-37

1 Push-pull dynamometer

See Fig. 4-37.

b) If a press machine is available, apply a pressure (P= 5420 kgf) on the upper side of the roller bearing inner ring and keep it, hook the $\Phi 14.5$ hole on the bearing sleeve with a push-pull dynamometer. The reading of the pull-push dynamometer shall be 5 ~ 35 N while the dynamometer is pulled in the tangential direction, or else the gasket thickness shall be increased or reduced. Repeat the above procedures, until the reading reaches the range of 5 ~ 35 N.

★ Notice:

Firstly, install the flange on the spline of the drive spiral bevel gear and fasten it with big nuts after the gasket is installed. Install the flange as per assembling mark or the mark made in advance, and measure the radial run-out of the flange with a run-out tester, making sure that it doesn't exceed 0.08.

Tonnage (T)	Axle Model	Torque	
		Flange nut	Rotary resistance torque
1	A513 A506	360±40 Nm	0.34-2.2 Nm
3	A507		0.43-3.0 Nm
4	A504		0.43-3.46 Nm
5	A512		
6	A508	850±100 Nm	0.5-3.5 Nm
7	A503	850±100	2-4 Nm

		Nm	
--	--	----	--

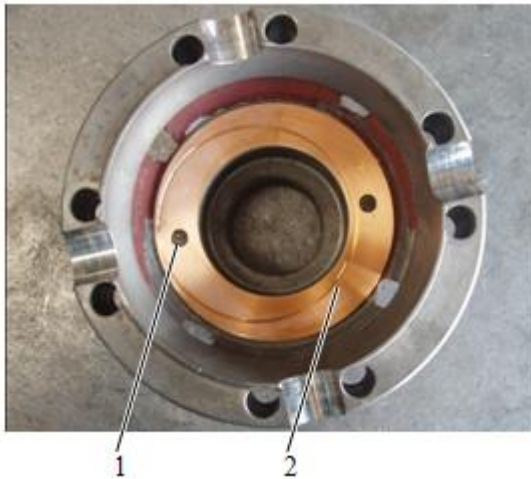

8 Installing face gear

- Install two retainer pins and the face gear gasket in the left differential housing in proper order.

★ Notice:

The retainer pin shall be knocked in gently as per the range shown in the drawing and make sure the dimension is 1.5-2 mm (measure it with a caliper while knocking it).

Fig. 4-38

1 Retainer pin

2 Face gear gasket

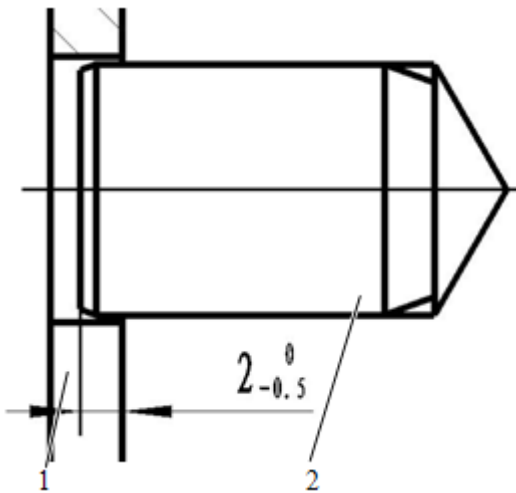

Fig. 4-39

1 Face gear gasket

2 Retainer pin



- Apply the lubricating oil while installing the face gear gasket and the face gear, and match the face with oil groove on the face gear gasket with the back side of the face gear.

 Lubricating oil

Fig. 4-40

1 Face gear

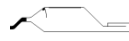
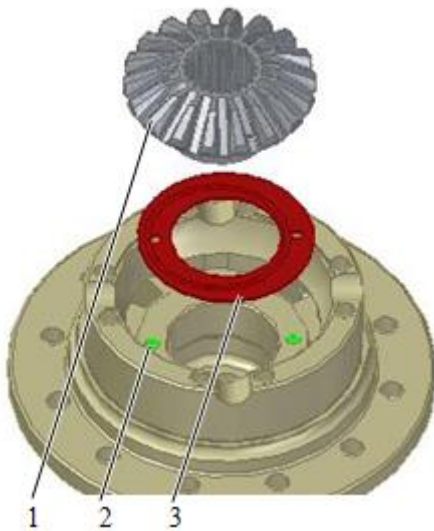

9 Installing the face gear

Install two retainer pins, the face gear gasket and the face gear into the right differential housing in proper order.

★ Notice:

The retainer pin shall be knocked in gently as per the range shown in the drawing and make sure the dimension is 1.5-2 mm (measure it with a caliper while knocking it).

Fig. 4-41

1 Face gear 2 Retainer pin

3 Face gear gasket

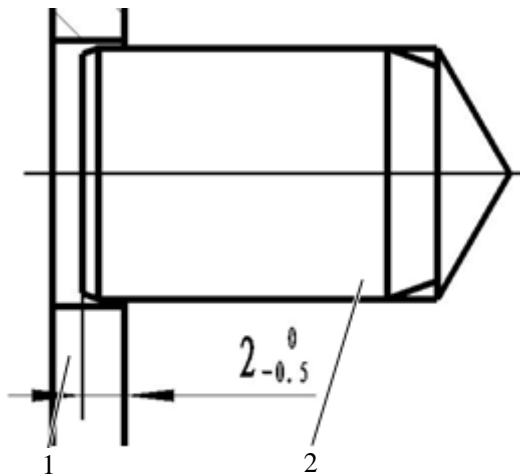

Fig. 4-42

1 Face gear gasket 2 Retainer pin

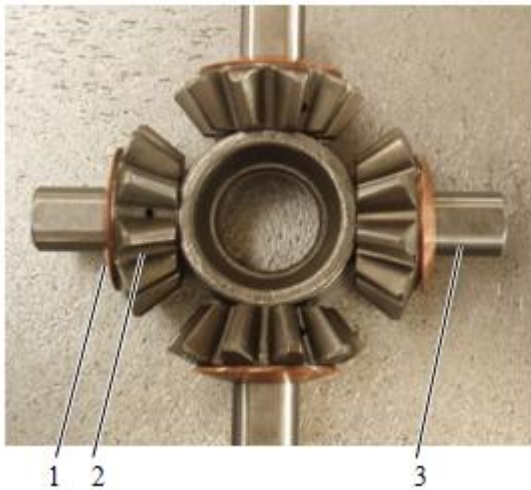

Fig. 4-43

- 1 Bevel gear gasket
- 2 Bevel gear
- 3 Cross shaft

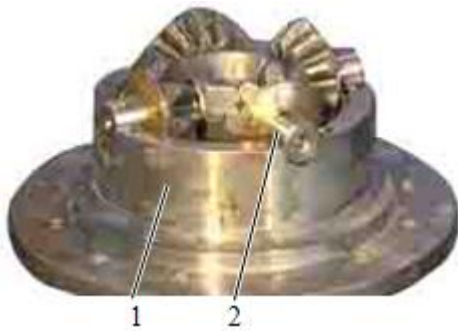

Fig. 4-44

- 1 Right differential housing
- 2 Universal joint assembly



Fig. 4-45

- 1 Nut and washer

10 Installing the cross shaft assembly

Install the bevel gear (with the small end inward) and bevel gear gasket on the four axle ends of the cross shaft in turns.

★ Notice:

The lubricating oil shall be spread while assembling the bevel gear and bevel gear gasket.

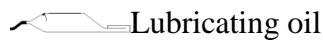

11 Installing the differential housing

- Install the cross shaft assembly into right differential housing and get the bevel gear to mesh with the face gear. After the face gear and the bevel gear are assembled, the differential can be rotated with hand easily without seizure.

- Reverse the left differential housing and integrate it with the right differential housing; connect and fasten the right and left differential housings together with washers and nuts.

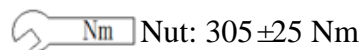

- Ensure that the assembling marks of the right and the left differential housings are aligned.

- Apply a proper amount of thread locking sealant 1262 at the bottom of the bolt thread.

Thread Locking Sealant 1262

Tonnage (T)	Axle Model	Torque
1	A513/A506	120±10 Nm
3	A507	195±15 Nm
4	A504	305±25 Nm
5	A512	
6	A508	265±27 Nm
7	A503	305±25 Nm



Fig. 4-46

1 Bolt

2 Nut and washer

12 Installing the driven spiral bevel gear

Aligning with the assembling mark, fasten the driven spiral bevel gear (the left spiral is used for the rear axle and the right spiral is used for the front axle) on the right differential housing with bolts, washers and nuts and then screw down the nuts.

Nm Nut: 305±25 Nm

- Apply a proper amount of thread locking sealant 1262 at the bottom of the bolt thread.

Thread locking sealant 1262

- Method of determining left and right spirals: facing the front of the gear, the one whose teeth extend clockwise from the small end to the big end is the right spiral; conversely, the one whose teeth extend from the big end to the small end counterclockwise is the left spiral.

Tonnage (T)	Axle Model	Torque
1	A513/A506	91 ±13 Nm
3	A507	305 ±25 Nm
4	A504	305 ±25 Nm
5	A512	
6	A508	
7	A503	



13 Installing the bearing

Install a roller bearing at the outer bearing position of the right differential housing.

Fig. 4-47

1 Bearing inner ring

2 Right differential housing



14 Install a roller bearing at the outer bearing position of the left differential housing.

Fig. 4-48

1 Left differential housing

2 Bearing



Fig. 4-49

1 Adjusting gasket

2 Bracket

15 Install the assembled drive spiral bevel gear assembly into the bracket.

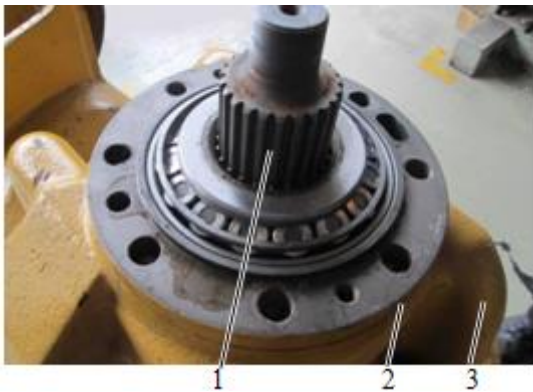

Fig. 4-50

1 Drive spiral bevel gear assembly

2 Adjusting gasket

3 Bracket

16 Fasten the bracket on the assembling rig with its small end on top. Coat the small end with sealant and install the adjusting gasket. The coating route and diameter of the bearing sleeve (the other side of the gasket) also meet the following requirements.

★ Notice:

- The coating route is as shown in the figure.
- Install again a gasket with the same thickness as per the thickness of the trace of the removed gasket for the purpose of commissioning.

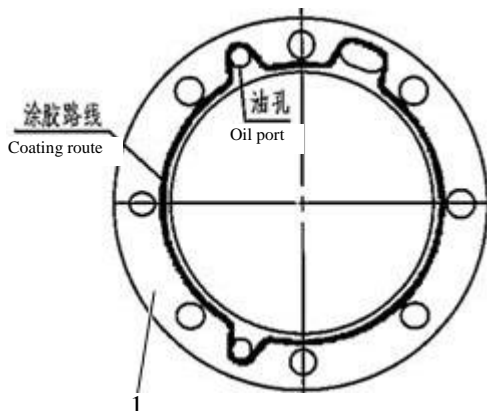

Fig. 4-51

1 Bearing sleeve



Fig. 4-52

1 Seal cover 2 Framework oil seal



Fig. 4-53

1 Bolt and washer

2 Seal cover

17 Installing the seal cover

Press the framework oil seal into the seal cover.

★ Notice:

Coat around the outer diameter of the framework oil seal with an appropriate layer of lubricating grease while installing it.

Mobil lubricating grease

18 Put the gasket on the end face of the bracket and connect the seal cover assembly with the support with bolts and washers.

Nm Bolt M14*55: 145 ±20 Nm;

Bolt M12*55: 91 ±13 Nm.

★ Notice:

Screw down the fixing bolts of the seal cover in proper order on the principle of symmetrical crossing.

Tonnage (T)	Axle Model	Torque	
		Seal cover bolt (small)	Seal cover bolt (big)
1	A513/A506	52 ±7 Nm	91 ±13 Nm
3	A507	91 ±13 Nm	145 ±20 Nm
4	A504	91 ±13 Nm	145 ±20 Nm
5	A512		
6	A508	/	

7	A503	
---	------	--



Fig. 4-54

1 Gasket

2 Input flange

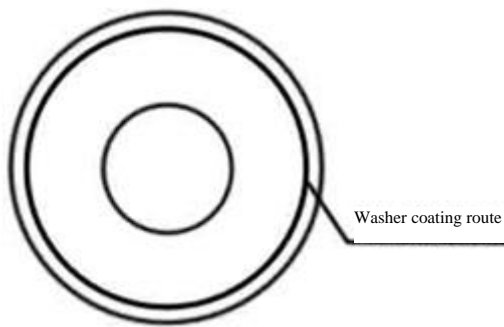

Fig. 4-55



Fig. 4-56

1 Nut

19 Installing the input flange

Coat one end face of the gasket with sealant, and install the gasket and input flange with the sealant face downward.

Sealant Tiemao 609

- The coating route is as shown in the figure.

20 Install and fasten the nuts M33*1.5.

Nm Nut: 360 ±40 Nm.

★ Notice:

- Install the flange as per the assembling mark or the mark made during the removal.
- Evenly spread the tree lace of $\phi 2 \sim \phi 4$ as close as possible to the outer annulus of the washer as per the route in the figure.

Tonnage (T)	Axle Model	Torque
1	A513/A506	360±40 Nm
3	A507	
4	A504	
5	A512	
6	A508	850±100 Nm
7	A503	850±100 Nm



Fig. 4-57

1 Differential assembly

2 Bracket

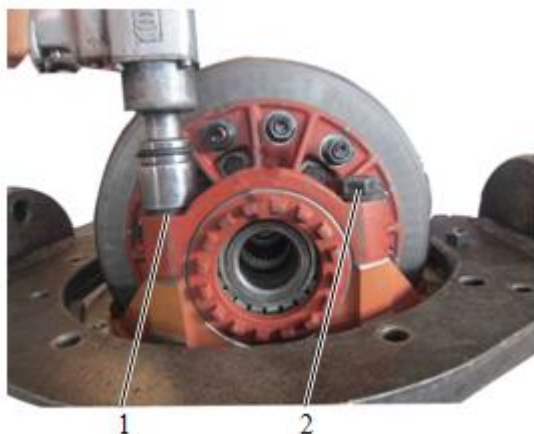

Fig. 4-58

1 Washer

2 Bolt

21 Installing the differential assembly

Turn over the bracket and install the differential assembly into the bracket.

22 Firstly install the adjusting nut, and then install the bearing seat with nuts and washers as per the mark (bolts shall be slightly tightened).

★ Notice:

- Two bearing seats cannot be exchanged.
- Apply a proper amount of thread locking sealant 1262 on the end face of the bolt thread.

 Thread locking sealant 1262



Fig. 4-59

1 Adjusting nut

23 Adjusting the spiral bevel gear

- The adjustment of spiral bevel gear engagement is to adjust the engagement zone and backlash. When adjusting the backlash of the spiral bevel gear pair, use a dial indicator probe to press the tooth on the edge of the driven spiral bevel gear big end and then rotate the driven spiral bevel gear to measure its backlash. The backlash shall be 0.2~0.4 mm. Refer to the table below.

- The backlash can be adjusted by screwing the adjusting bolt to change the position of the driven spiral bevel gear (if necessary, drive spiral bevel gear can be moved for adjustment). If the backlash is bigger than the specified value, move the driven spiral bevel gear toward the drive spiral bevel gear; conversely, move it away. In order to keep the adjusted preload of the differential tapered roller bearing the same, the number of screw-in circles for the adjusting nuts at one end shall be equal to the number of screw-out circles at the other end.

- When adjusting the contact zone of the spiral bevel gear pair, firstly apply some red paint (like red lead power, etc.) on the driven spiral gear teeth (usually paint 2-3 teeth), then rotate the driven spiral bevel gear repeatedly with hand to check its contact trace.

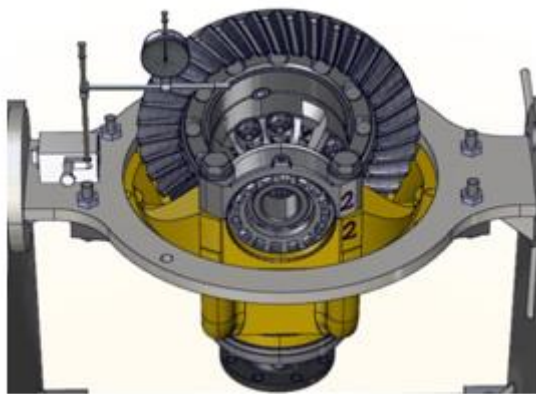
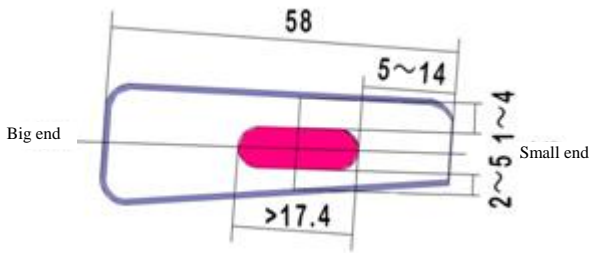
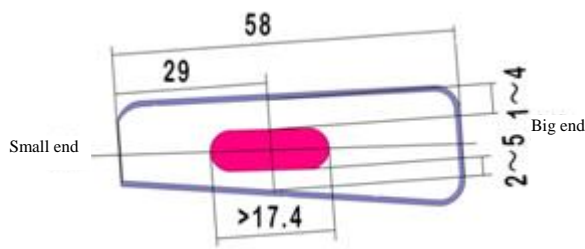

Fig. 4-60



Convexity of Spiral Bevel Gear

- Adjust the engagement trace of the spiral bevel gear to its correct position: not less than 50% along the ^{Small end} height and length of its teeth, the engagement trace on the driven bevel gear close to its center, in the middle of the teeth along the height of the teeth and slightly closer to the small end along the length of the teeth. Increase the preload of the differential bearing: after the backlash of the spiral bevel gear is adjusted, make sure that the backlash between the tapered roller bearings at both ends of the differential is 0. See Table 4-5 for adjustment method.



Concavity of Spiral Bevel Gear

★ Notice:

- The engagement zone is usually adjusted by increasing/decreasing the adjusting gaskets and rotating the adjusting nut. The adjustment of contact zone has a significant influence on the performance and service life, thus it shall be conducted seriously.
- After the adjustment is completed, clean the red lead powder.

Fig. 4-61

Tonnage (T)	Axle Model	Gear Backlash
1	A513/A506	0.15 ~ 0.35
3	A507	
4	A504	0.2 ~ 0.4
5	A512	
6	A508	0.20 ~ 0.35
7	A503	0.3 ~ 0.4

Table 4-4

Axle Model	A513/A506A/A506B	A506	A511	A502/A504A/ A505/A507/A510/ A510B/ A512/A515	A508/A508A	A503
A	37	70	40	58	78	80
B	5 ~ 14	5 ~ 14	5 ~ 14	5 ~ 14	5 ~ 14	5 ~ 14
C	1 ~ 4	1 ~ 4	1 ~ 4	1 ~ 4	1 ~ 4	1 ~ 4
D	>11.1	>23	>12	>17.4	>26	>27
E	2 ~ 5	2 ~ 5	2 ~ 5	2 ~ 5	2 ~ 5	2 ~ 5
F	18.5	30 ~ 39	20	29	35 ~ 43	35 ~ 43

Adjustment of Contact Zone and Backlash during the Installation of Spiral Bevel Gear

Table 4-5

Driven Bevel Gear Circular Tooth Contact Zone	Adjustment Method	Moving Direction of Gear
	Move the driven gear towards the drive gear; if the backlash is too small, move the drive gear outwards	
	Move the driven gear away from the drive gear; if the backlash is too big, move the drive gear inwards	
	Move the drive gear towards the driven gear; if the backlash is too small, move the driven gear outwards	

	<p>Move the drive gear away from the driven gear; if the backlash is too big, move the driven gear inwards</p>	
--	--	--

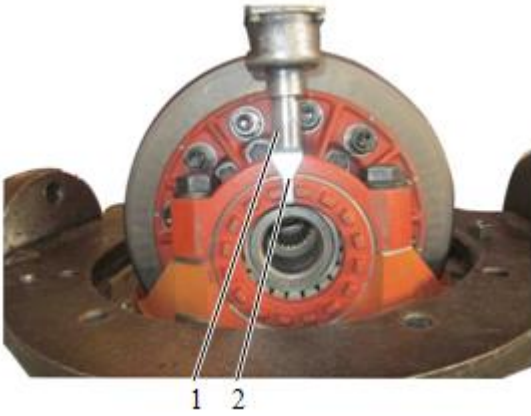

Fig. 4-62

- 1 Bolt and washer
- 2 Locking plate

24 Installing the locking plate

Fasten the fixing bolts of the bearing seat; put the locking plate in place and fix it on the bearing seat with the fixing bolts and washers, and then screw down the fixing bolts.

Nm : 45 ±5 Nm;

550 ±50 Nm.

★ Notice:

Apply a proper amount of thread locking sealant 1262 on the end face of the locking plate fixing bolt thread for a length of 5~10 mm.

Thread Locking Sealant 1262



Fig. 4-63

- 1 Thrust bolt
- 2 Copper sleeve

Tonnage (T)	Axle Model	Torque	
		Bearing seat bolt	Locking plate bolt
1	A513 A506	225 ±32 Nm	52 ±7 Nm
3	A507	500 ±50 Nm	45 ±5 Nm
4	A504	550 ±50 Nm	45 ~ 59
5	A512		45 ±5 Nm
6	A508	520 ±40 Nm	52 ±7 Nm
7	A503	700 ±70 Nm	45 ±5 Nm



Fig. 4-64

1 Locking plate

25 Installing the thrust bolt

Turn over the bracket, press the copper sleeve into the end of the thrust bolt and then screw it into the bracket to make the copper sleeve contact the back of the driven spiral bevel gear in the differential assembly; reverse it for 1/6-1/4 circle and fasten it with nuts and locking plate.

26 Bend one tooth of the locking plate to prevent the nut from loosening.

5 Criterion for Repair and Replacement of Drive Axle Parts

I. After removal, identify whether the parts are out of service based on whether the parts completely lose their functions (usability) or whether they are completely irreparable.

II. In general, there are two ways to identify the parts after removal:

Visual check and touch; dimension measurement;

III. Firstly conduct a preliminary assessment of the disassembled parts by visual checking and touching, replace and never use the following defective parts:

- 1 Parts with serious bumping, cracks, fracture or loss of function;
- 2 Oil seal, scraper seal, O-ring and sealing gasket, removed due to leakage, which have poor reliability and short service life in reuse.
- 3 Bolts, nuts, washers, plugs and pipe connectors with serious rust, threads that disable normal screwing-in or have bumping, excessive wear or thread stripping.
- 4 Assembled and disassembled bearing parts by principle, except those for the whole machine that works not longer than 100 hours and barely suffering damages from the disassembling and assembling.
- 5 Bearings that are rotated hardly with hands due to clamping stagnation, or whose components have cracks, serious wear of race ways are seriously worn, and balls are damaged.
- 6 Gear or spline teeth with cracks, flake stripping, bumping and excessive wear.
- 7 Housing that has with cracks, or whose bearing mounting holes have cracks, wear, elliptical or flake stripping, or whose housing threads are damaged leading to the normal screwing and the its continuous service.
- 8 Bearing seat or oil seal seat whose fitting surface/spigot has cracks, wear, elliptical bump or flake stripping and bumping.
- 9 Bevel gear gaskets or planetary gear gaskets which become unusable due to their serious wear, cracks, bumping or flake stripping.
- 10 Pins that become unusable due to their serious wear, bumping, and cracks.

11 Wheelside supporting shaft, half axle and flange whose splines or teeth have bumping, excessive wear or cracks, or the workpiece (used for mounting the oil seal or bearing) with cracks on its surface.

12 Parts subjected to great bending moment, such as axle housing, supporting shaft, half axle, if there are cracks or tiny cracks at the transition or adjacent part of their arc, chamber and splines.

IV. The measurement method shall be adopted to identify if visual check and touch fail, and identification of common vulnerable parts shall be carried out by reference to the table below.

Table 5-1 Unit: mm

Part Type	Item	Criteria		Solution to Out-of-tolerance
		Size (tolerance)	Allowable limit	
Bearing	Inner diameter tolerance	About 0 ~ -0.02	+0.02	Replacement
	Outer diameter tolerance	About 0 ~ -0.02	-0.04	
Gear	Tooth thickness wear	About 0 ~ 0.10	12% of the tooth thickness of reference circle (always take 1.2 ~ 1.4 and take 2.0 for spiral bevel gear)	Replacement
Bevel gear gasket	Thickness	1.5 ±0.06	1.2	Replacement
Face gear gasket	Thickness	2.3 ±0.075	2.0	Replacement
Cross shaft	Outer diameter φ28.55	-0.007 ~ +0.014	φ28.50	Replacement
Bevel gear	Inner diameter φ28.7	0 ~ +0.05	φ28.65	Replacement
Common part	Outer diameter for general fitting	Tolerance denoted as T	Recommendation: 0.3 T less than the lower limit	Replacement
	Inner diameter for general fitting	Tolerance denoted as T	Recommendation: 0.3 T greater than the upper limit	

6 Diagnosis and Elimination of Common Fault

6.1 Diagnosis and Elimination of Drive Axle Fault

6.1.1 Abnormal Noise of Drive Axle

(1) Phenomenon and hazard

- There are various abnormal noises of drive axle: some are continuous and some are intermittent; some occur during speed change and some occur during normal driving; some appear in uphill courses and some appear in downhill ones; some sound tedious and some are silvery.
- The noises of drive axle generally come from the main driver and the differential and some also occur at wheel reducer. The abnormal noise of drive axle reflects the abnormal technical condition among the drive axle parts, thus we shall find out the relevant cause and make resolution, and otherwise it may cause a more serious fault or even an accident.

(2) Causes and elimination of abnormal noise of drive axle

- The abnormal noise of drive axle are mostly resulting from the collision or interference among the inside (including the wheel reducer) parts. Due to the different intensity and different characteristics of the noise generated by different parts at different states, we can determine the source of abnormal noise and find its cause according to the condition and position of the generated noise.

According to the causes, the abnormal noise falls into two types:

- One is the noise generated due to the loose inter-part connection or damaged parts. It is always arising from the abnormal friction and collision among parts, thus it sounds clear; the other is the noise resulting from abnormal bearing fitting or abnormal gear engagement.
- The abnormal gear engagement means the too narrow or too wide backlash, wrong engagement position or insufficient engagement area, leading to continuous and clear noise which grows louder as the speed increases; the abnormal bearing fitting means the too narrow or too wide bearing clearance, and when the clearance is too wide, there will be continuous noise which grows louder as the speed increases.

- When noise occurs at axle body, besides checking whether the parts are loose, we shall firstly check whether the engagement zone and backlash are proper. If not, make a proper adjustment.

The adjustment of engagement zone is generally performed by increasing or decreasing the adjusting gaskets and screwing the adjusting nuts. The adjustment of contact zone must be carried out carefully because of its great influence on the operational performance and service life.

6.1.2 Heating of Drive Axle

(1) Phenomenon and hazard

The heating of drive axle means that the temperature of drive axle exceeds the allowable range of normal temperature rise after the axle works for a period. The axle feels hot when you touch it. The heating phenomenon mainly occurs at the drive axle body (except the main driver and the differential) and the wheel reducer. It is also caused by the abnormal technical condition, fitting condition or lubrication of the drive axle parts, thus it shall be eliminated timely for fear of damaging the relevant parts.

(2) Cause and elimination of heating of drive axle

- There are two causes of the heating of drive axle: one is the large quantity of generated heat; the other is that the heat can't be dissipated in time.
- The heat source of drive axle is mainly the friction heat which is mostly generated by too narrow fit clearance between parts in relative movement. The fitting parts of drive axle include bearings and gears, thus the heating of drive axle is primarily caused by the too narrow bearing fitting clearance or too narrow gear backlash.
- The major reason for the failure of drive axle heat dissipation is the lack of oil or the poor oil quality in the drive axle (and the wheel reducer). In this case, the friction heat generated by drive axle cannot be dissipated timely, and additionally, the parts in relative movement will be in dry friction, greatly increasing the friction heat.

We can determine the cause of heating according to the heating position. For example, the heating at bearing means it is caused by too narrow bearing fitting clearance; the heating of the whole

drive axle housing may be caused by the abnormal gear engagement or lack of oil which requires a timely injection of standard gear oil. It is also possible that the temperature of brake fluid rises because of the heat generated by friction since the brake caliper does not return.

6.1.3 Oil Leak of Drive Axle

(1) Phenomenon and hazard

The oil leak of drive axle always occurs at axle body and the wheel reducer, and in most case, the oil leaks through the sealed joint surface. The oil leak causes not only the heating of drive axle which influences relevant performance but also the environmental pollution.

(2) Cause and elimination of oil leak of drive axle

The oil leak of drive axle is mainly caused by the damage of seals or packings.

In case of oil leak, check the oil seal for aging, cracks or damage; never pull the oil seal by great force to avoid plastic deformation; try to immerse the oil seal in liquid with temperature close to its working temperature so as to warm it and then install it; use special tools to conduct the installation as per relevant technology.

6.2 Drive Axle Maintenance

6.2.1 Oil Level Check

During maintenance, it is required to inject fresh gear oil. Level the indicatrix on the wheelside end cover of the drive axle and the whole machine during the oil injection process. If there is oil overflowing out of the filler on axle housing and wheel reducer, it's full. Be careful of the spattering hot oil when screwing off the plug for oil outlet.

6.2.2 Maintenance

Replace the oil after the first 250 working hours of the new vehicle, and after that, replace the gear oil of the front and rear axles every 1,000 working hours (half a year) and conduct an inspection under disassembled condition every 2,000 working hours (one year). Perform maintenance strictly as per the requirements in the operation and maintenance manual.

- Requirements on every-50-hour maintenance (every week):

Check and fasten the connecting bolt of wheel rim and brake caliper.

- Requirements on every-250-hour maintenance:

Check whether the connection of the front and rear axles and the frame is loose.

Check the tire pressure: for 16PR tire, the pressure of the front tire is 0.333 ~ 0.353 MPa and of the rear tire is 0.275 ~ 0.294 MPa; for 18PR tire, the pressure of the front tire is 0.383 ~ 0.403 MPa and of the rear tire is 0.325 ~ 0.3444 MPa.

- Requirements on every-1,000-hour (every half year) maintenance

Replace the gear oil of front and rear axles.

- Requirements on every-2,000-hour (every year) maintenance:

Mainly check the operational performance of the main drive assembly and wheel reducer assembly.

Check the clearance, engagement and wear of the main drive spiral bevel gear pair.

Check the wear of the reducer gear and the bevel gear gasket.

Check the wear of the wheelside gear.

Check the wear of the wheelside planetary gear needle and the bearing.

- The above maintenance is the basic requirement for normal operation. In case of poor working condition, the user shall shorten the maintenance interval and increase the maintenance frequency according to actual demands.

6.2.3 Other Inspections

- The continuous operating temperature of axle shall not exceed 90°C. If the temperature is greater than 130°C, stop the machine and check the braking system and the drive axle.
- Adopt multi-purpose grease with the following properties: lithium base saponated grease with dropping point of 170°C and class of NLGI2. The grease must have such properties as corrosion resistance, water resistance and extruding stability. The grease shall be injected into the grease nipple once a week.
- Regularly check the tightening torque of the connecting bolt of all drive axles and frames/transmission shafts/wheel rims, and perform the initial inspection on torque after the first 50 working hours!



Shandong Lingong Construction Machinery Co.,Ltd

Address:Lingong Industry Park,Linyi Economic Development Zone,Shandong,China

Tel:0086-531-66590966

Fax:0086-531-66590959

Customer Service Tel:0086-531-66590955

Email:export@sdlg.com.cn

<http://www.sdlg.cn>